

RADIO RETAILING

25 CENTS PER COPY

McGraw-Hill Publishing Company, Inc.

NOVEMBER
1938

TO HELP
YOU SELL NEXT MONTH
WE GIVE YOU THIS MONTH

Fine Furniture For
Holiday Radio Buyers

OTHER FEATURES
IN THIS ISSUE

Special Test Equipment and
Replacement Parts Section
... How to Sell Records, Rec-
ord Players and Combina-
tions... New Sound Survey
... Four Winning Ways to
Sell Tubes... First Aid for
the Floor Man... Plus News,
Preview of New Products,
Radio Retailing's Exclusive
and Unique Business Barom-
eter, Photoshots, Circuits
and Tricks of the Trade.



BOY, DID I GET A JOLT!
to find all this swell!

**NEW information in the
SECOND (1938) edition of the
MALLORY-YAXLEY
Radio Service Encyclopedia**

ALL BRAND NEW
... you won't find it
in the **FIRST EDITION**

Even if you own a copy of the First Edition MYE you haven't seen anything until you've seen the Second Edition. It has 336 pages against 200...analyzes 17,000 receivers (5000 more than the First Edition)...packed from cover to cover with substantiated data that you have never even hoped could be brought between the covers of one book... *much information that has never been available anywhere before.*

Mallory-Yaxley has invested over \$100,000.00 to make this the book of books for radio service men. You can't begin to appreciate what it's like or how much bigger and better it is than the First Edition until you've actually gone through it.

Your distributor still has a limited supply available. Don't be disappointed!
Be sure to get your copy today.

• You'll pay for it with the time you save on one job

AUTOMATIC FREQUENCY and ALIGNMENT
up-to-date including Triple Detection

AUDIO DEGENERATION
... circuits and how they work

'SCOPE PICTURES
.. fully explaining vibrator operation

COMPLETE TUBE CHART
arranged numerically and alphabetically

AUTOMATIC TUNING
... all push button circuits covered

AUDIO DISTRIBUTION
With multiple speaker installation, impedance matching and volume control

NUMBER of each type of tube in every receiver

P. R. MALLORY & CO., Inc.
INDIANAPOLIS INDIANA
Cable Address—Pelmalla

Use **MALLORY** REPLACEMENT CONDENSERS...VIBRATORS

Use **YAXLEY** REPLACEMENT VOLUME CONTROLS

RADIO RETAILING



A McGRAW-HILL

PUBLICATION

NOVEMBER 1938

O. FRED. ROST Editor
 W. MacDONALD Managing Editor
 C. A. NUEBLING Technical Editor
 J. H. AVELING Assistant Editor
 HARRY PHILLIPS Art Director

Tom Blackburn
 Chicago

George Tenney
 San Francisco

H. S. Knowlton
 Boston

H. W. MATEER
 Manager

LEE ROBINSON
 Sales Manager

McGRAW-HILL PUBLISHING COMPANY, INC.

JAMES H. MCGRAW
 Founder and Honorary Chairman

Publication Office
 99-129 North Broadway, Albany, N. Y.
 Editorial and Executive Offices
 330 West 42nd Street, New York, N. Y.

Cable Address: MCGRAWHILL, New York
 Member A.B.P. Member A.B.C.

James H. McGraw, Jr. President
 Howard Ehrlich Executive Vice-President
 Mason Britton Vice Chairman
 B. R. Putnam Treasurer
 D. C. McGraw Secretary
 J. E. Blackburn, Jr. Circulation Manager

RADIO RETAILING, November, 1938, Vol. 23, No. 11. Published monthly, price 25c copy. Subscription rates—United States and possessions, Canada, Mexico and Central American countries, \$1. All other countries \$2 a year or eight shillings. Printed in U. S. A. Entered as Second Class Matter, September 8, 1936, at Post Office, Albany, N. Y., under the Act of March 3, 1879. Cable address "McGrawhill, New York." Member of A. B. P. Member of A. B. C. Copyright 1938 by McGraw-Hill Publishing Co., Inc., 330 West 42d Street, New York, N. Y.

Branch Offices: 520 North Michigan Ave., Chicago; 883 Mission St., San Francisco; Aldwych House, Aldwych, London, W C 2; Washington; Philadelphia; Cleveland; Detroit; St. Louis; Boston; Atlanta, Ga.

RADIO MONTH, BUSINESS BAROMETER	By O. Fred. Rost	7
EFFECTIVE BATTERY SET DEMO		9
SALES PHOTOSHORTS		10
FINE FURNITURE FOR THE HOLIDAYS	By J. H. Aveling	12
REPORT ON TELEVISION		14
MORE DOLLARS PER SALE		17
RECORDS SPRINT FOR THE GOALPOSTS	By Richard Gilbert	18
RECORD PLAYERS TO FIT THE PURSE		20
DINNER MUSIC AT EIGHT	By Tom Blackburn	22
NEW CONSOLES		33
NEW TABLE MODELS		34
NEW ALLIED LINE PRODUCTS		39
NEW RADIO PARTS		42
NEW TEST EQUIPMENT		43
4 WAYS TO SELL TUBES	By Josephs, Bauer, Hatry, Shirek	44
FIRST AID FOR THE FLOOR MAN	By Caswell Oden	46
SELLING SERVICE		49
HOW TO MAINTAIN A PARTS STOCK	By Harold F. Jenkins	50
TEST EQUIPMENT YOU NEED	By C. A. Nuebling	52
SERVICE SHOP MODERNIZATION	By Ralph Merkle	56
CIRCUITS		67
TRICKS OF THE TRADE		76
SOUND IN NEW ENGLAND	By Fred Merish	81
AUDIO FREQUENCY		88



You Demanded
CORNER CABINET
in **WALNUT...**

HERE IT IS! THE NEW
 No. 340-W

Authentic Tudor Period Design, Styled from an old English Corner Cabinet of the 17th Century, With the Labyrinth . . . **ONLY \$125** f. o. b. Rochester

Enthusiastic overmounting sales of the new Corner Cabinet in *maple*, Stromberg-Carlson dealers everywhere have been begging for a low-priced Corner Cabinet in *walnut*. So we've driven the designers, driven suppliers of fine veneers, driven the factory—and now, at the height of the season, you have it. Corner Cabinet Radio — the new style made possible by the Labyrinth — is on its way to scoring sales records. Ride with the tide. Order now.

Stromberg-Carlson Telephone Mfg. Co.
 Rochester, N. Y.

How the Labyrinth Improves Tone.

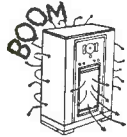

THE TROUBLE—Empty cabinet space in back of the speaker causes "boom" and distorts the pure tone from the front of the speaker.

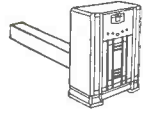

THE THEORY—A long tube of sound absorbent material would absorb the unwanted sounds and reinforce the bass tones.



THE THEORY MADE PRACTICAL—Such a tube is out of the question. So Stromberg-Carlson folded it into a Labyrinth.

THE PATENTED LABYRINTH—The Labyrinth in one of the new Stromberg-Carlsons. It is the necessary baffle wrapped up, folded over and placed in the troublesome space in cabinet. Pat. in U.S.A. and Canada.

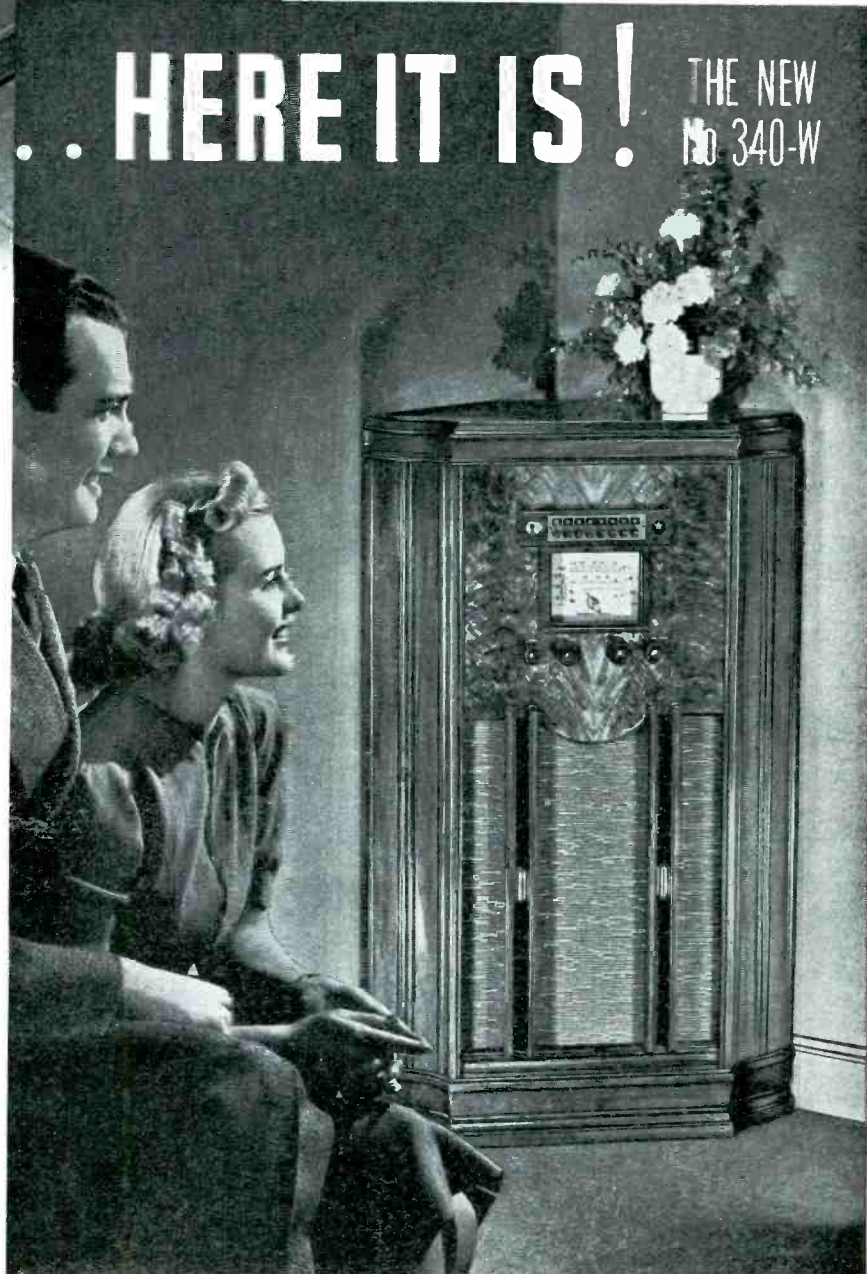
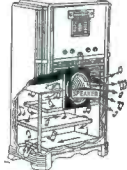

THERE IS NOTHING FINER THAN A

Stromberg-Carlson

American Airlines, Inc.
GIANT FLAGSHIPS
Fly with
RAYTHEON TUBES!

With radio beams to mark the air lanes clearly . . . two-way radio communication between plane and ground . . . and precision instruments to guide the pilots, commercial air transportation has now become one of the safest, most dependable ways to travel.

Weather is reported—arrivals, departures and the very courses planes fly are directed by radio.

For this important work, American Airlines, Inc. use RAYTHEON radio tubes! A weak or inefficient tube has no place in a fleet-winged Flagship. And American knows the reputation RAYTHEONS have for sturdiness and longevity—and for perfect, dependable performance under all conditions.

Successful Dealers and Servicemen—those who are in business to stay are finding that RAYTHEON tubes are their insurance of the best—for permanent tube profits. And a wise investment. Yet they cost *no more* than the second-best tube!



RAYTHEON

NEWTON, MASS. • NEW YORK • CHICAGO • SAN FRANCISCO • ATLANTA

"WORLD'S LARGEST EXCLUSIVE RADIO TUBE MANUFACTURERS"

**Mr.
Dealer**

**\$40
PROFIT**



**100%
MORE CURRENT
OUTPUT**

than any 6-volt
wind-electric unit
now on the market

**STARTS CHARGING
IN A 6-MILE BREEZE**

**IN
WINCHARGER'S
NEW
"LIGHT AND RADIO"
Profit Package**

LOOK! \$40 PROFIT!
ON A \$99.50 RETAIL PACKAGE

[New 6-volt Heavy Duty Wincharger
Wincharger Heavy Duty Batteries
Light Bulbs and Wiring Kit
Farm Radio Set
Installation]

**WHY BE SATISFIED WITH SMALL MARGINS WHEN YOU CAN
TRIPLE YOUR PROFITS ON RADIO SALES!**
WRITE WINCHARGER CORPORATION FOR FULL DETAILS

HERE'S the greatest money making opportunity in years! A chance to boost farm radio sales and triple your daily profits. Made possible by Wincharger's new HEAVY DUTY 6-VOLT charger—the outstanding 6-volt unit on the market today. Actually puts out 100% MORE current than any other 6-volt charger. Generates enough current for all the Electric Lights and Radio Power the ordinary farm family can use. Starts charging in a 6-mile breeze. Has a top output of 25 amperes. Opens up a brand new market for radio dealers in low wind areas. Equipped with a giant oversize 7½ inch generator and 7½ foot patented Air Foil Propeller. Furnished with 10 foot tower. List price \$39.95 F.O.B. Sioux City, Iowa, with a liberal profit margin for dealers. Available January 1st in both 6 and 12 volt capacities.

**NEW Profit Package GREATEST VALUE
EVER OFFERED THE FARM MARKET**

This new "Light and Radio" Profit Package is a "natural" for the farm market. Wrapped up in a package for the first time is everything the farmer needs for plenty of electric lights and radio power... priced at a figure every farmer can afford. Early indications point toward an enthusiastic consumer acceptance for this "Light and Radio" Package. Don't hesitate. Stock up early! Use this proved plan of merchandising "free power" for electric lights to stimulate your farm radio sales, boost your dollar volume, and triple your profit per sale.

**WINCHARGER CORP. SIOUX CITY
IOWA**

Replacements that Make the Receiver
"BETTER THAN EVER!"

"UNIVERSAL—ADJUSTABLE"
Antenna—R. F.—Oscillator Coils

IT IS no longer necessary to order hard-to-get exact duplicates when an Antenna, R. F. or Oscillator coil needs replacing. These new adjustable-inductance Ferrocart (Iron Core) coils will replace the Broadcast Band coils in practically any receiver! The Oscillator coil is also designed to provide complete adjustment for receivers having intermediate frequencies from 175 to 520 kc, and may be used in either cut-plate tuning condenser or padding condenser circuits.

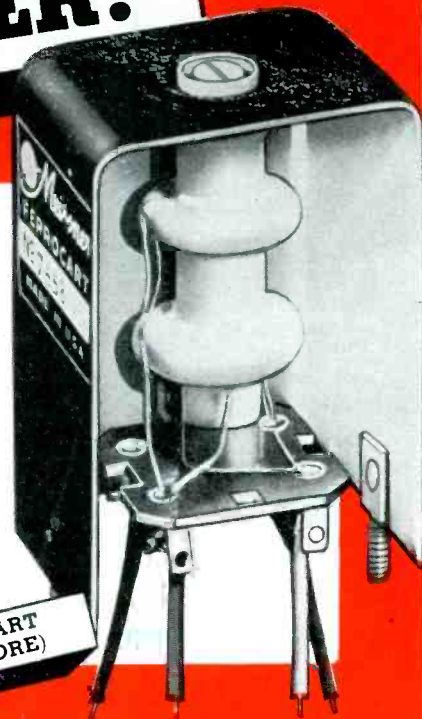

FERROCART
(IRON CORE)



FERROCART
(IRON CORE)

Band Expanding I. F. Transformers . . .

These Ferrocart (Iron Core) Band Expanding I. F. Transformers meet all requirements for variable selectivity—razor-sharp, medium width or broad band for high fidelity reception. Band width is electrically variable by means of a switch.

Double-Tuned I. F. Transformers

This is the ideal replacement transformer for Servicemen and Experimenters who demand the utmost in I. F. transformer performance at low cost. Available factory-peaked at 175, 262, 370, 456, 1500 or 3000 kc.



CERAMIC BASE
MICA TRIMMERS



FERROCART
(IRON CORE)

Ferrocart Antenna & R. F. Coils

These (Iron Core) coils are designed to cover the broadcast band (540 to 1600 kc) with a 365 mmf condenser. Will work with any of the standard types of tubes, including metal and the battery-operated 2-volt series.

Meissner

MT. CARMEL
ILLINOIS

"A FAMOUS NAME FOR TWO DECADES"



HARRY BOYD BROWN
National Merchandising
Manager of Philco

The Public Tells Us . . . "Philco has set a new vogue in radio furniture . . . Spinet!"

IN our 1939 Philco announcements to the trade we told you two things. First, that Philco Mystery Control would be the most sensational store-traffic puller the radio industry has ever known. Second, we told you that the new Philco "Spinet Type" cabinets would start a new trend in radio furniture design.

Both predictions have come true, as Philco dealers in every section of the country can testify. And if it were not for the tremendous interest caused by Philco Mystery Control, the public's reception of the new Philco Spinet Type cabinets would easily be the Big News of radio for 1939.

Nothing in radio history has won such instant and overwhelming approval from the women of America as this new Philco cabinet design. It is exactly what the younger generation in particular has been demanding.

Home decoration experts and the retail furniture industry everywhere pronounce it the one and complete reply to the demand for a radio cabinet that would look well—*not only on the dealer's floor, but also in the customer's home.*

For years, America's homemakers have yearned for radio furniture that would blend and harmonize with the settings of their rooms—for cabinets that would not stick out like a sore thumb and smother and dwarf the other furnishings of the room.

In short, the American women have demanded a new deal in radio cabinets that would permit them to take pride in their home furnishings. And dealer and public alike agree that it is here in the new Spinet Type of radio created by Philco for 1939.

The latest thing in radio cabinet design—furniture of distinguished simplicity—a new vogue, a new style trend that is rapidly doing away with the old type, bulky, bulging, box-like kind of cabinet.

Some places it is called "*Spinet*"; other places "*Period*"; somewhere else "*Modern*"; but everywhere it is called the most beautiful, the most distinctive and artistic radio cabinet ever designed. A radio style development that will obsolete old-fashioned radios by the hundreds of thousands.

And the radio dealers of America are taking the fullest advantage of the rapid public trend toward this new "Spinet" styling in radio. Artistic window displays by the many thousands—beautiful floor displays exclusively "Spinet" type radio models—also direct mail—also newspaper advertising. And most important of all, the retail salesman is adding to the momentum of this style movement with that selling power he alone possesses.

Harry Boyd Brown

PHILCO

The RADIO MONTH

NOVEMBER

1938

Microbe Marvels We are suffering from an epidemic of extremely low priced sets. Nobody makes any money on them. The parts manufacturer can't break even. The set maker is merely trading dollars. The distributor has to handle 3, 4 or 5 times as many units to get the same meagre gross that he would get on a \$69 console. The poor retailer is worse off than any.

He has to display, demonstrate, test, sell, pack and often deliver one of those Microbe Marvels, and, when he is all through, he may have the magnificent sum of \$2.50 or \$3.50 as *gross* reward for his effort. If he is lucky enough to sell a dozen in one week, he will have as much *gross* profit as he would get on one \$89 console, to say nothing of the fact that with each sale of a Microbe Marvel he loses a potential customer for a set on which he might have made a profit. When it comes to paying the rent, light, other overhead or getting some *net* profit after the expenses are paid—bring on the magicians.

We admit that there is a legitimate place for small sets in normal times, and when we have hard times, like last winter, the low priced sets help to keep the wheels moving.

But now we are pulling out of those hard times, temporarily at least. There is more money around and during the ensuing holiday shopping period the public is going to spend more freely than in the last 18 months. Therefore:

It's time to trade up!

Play up the higher priced models of the same manufacturer. Push every buyer at least one price bracket higher than he intended to go. Push combination radio and phonograph models. Make up your mind that you are going to stop going around in a squirrel cage and

getting nowhere for your effort.

Trade-up and fight to make a real *net* profit on every sale.

It can be done!

Television You will be interested in the news report on commercial television, which appears in another part of this issue.

We wish to reiterate here what has been emphasized previously, viz: Technically, video transmission over a maximum distance of 50 miles is possible. The economic problems of commercial television remain unsolved. Even if financial support for the erection of numerous transmitting stations were available, it would take a year or more to obtain the necessary equipment, some months for installations, additional months for training studio personnel.

In other words, unless you are located in a territory where an experimental transmitting station IS NOW IN OPERATION OR BEING ERECTED you need not expect television until 1940 at the earliest. Meanwhile, tell your prospective customers that if they buy a good radio set now, *it will not become obsolete* when, if and as television reaches there, because it can be used as the audio unit and will cut the necessary investment in a television receiver down to the cost of the video unit.



EDITOR

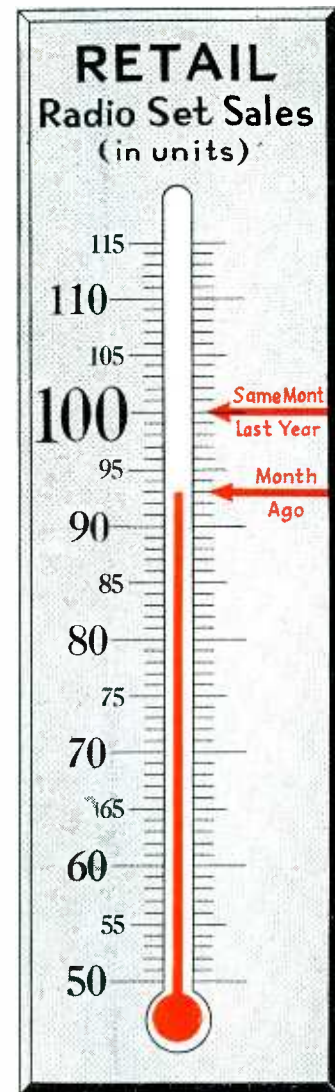

October Sales Business Barometer

RETAIL sales of radio sets during October maintained the same pace as in September, held to just 7% below last year's October and thus leave our sales index at 93.

This must be considered an excellent performance, not only because in other lines of retail trade October sales seem to have dipped much further below last year's level, but particularly because October last year accounted for fully 1/5 of the whole year's radio sales. Translated into units, this means that dealers this year had to move approximately eight hundred thousand radio sets during the month of October in order to keep our index within 7% of last year.

The cheerful record of unit sales is further sweetened by definite indications that public buying is slowly working into higher price brackets. Dealers in large numbers report that in their territory interest is shifting from the extremely low priced midget sets to more expensive table models and many say that record-playing radio-phonograph combinations and separate record players are gaining.

Battery radio sets appear to be moving well in most territories under the impetus given by the new low-drain 1.4 volt tubes. Several dealers even complain that they can't get deliveries fast enough.

Some dealers in Florida, Georgia, Kentucky, Pennsylvania, South Dakota, Tennessee and Wisconsin are reporting more than seasonally good business.

Out in California low prices on some of the major money crops held October sales down. In Mid-Central states, low prices of corn, oats, beans are the chief complaint.



**This year she
wants an Electrical Gift ★**

★ A Ross Federal Survey made for Sales Management backs up General Electric's prediction...proves that more women want electrical appliances than any other gift this Christmas. (See October 1st Sales Management, page 18.)

The G-E Christmas Theme



*For the Practical Person
with a Sentimental Side!*

appears in 33,450,215 ads in 31 days!

Here's a Christmas theme you can merchandise. It is built around all G-E appliances...refrigerator, range, dishwasher, disposal, ironer, washer, vacuum cleaner, radio and many small household appliances. Make it your own. Ask your customers to give "hours of freedom". Display the G-E gifts as advertised. Put up reprints of the advertisements. Make your store headquarters for Christmas' most wanted gifts. Wind up 1938 in a blaze of sales and profits!

A tremendous campaign timed right on the nose!

Saturday Evening Post	Nov. 26, Dec. 3
Collier's	Dec. 3, Dec. 10
This Week	December 4
American Weekly	December 11
Liberty	December 10
Good Housekeeping	December
American Magazine	December
American Home	December
Esquire	December
Country Gentleman	December

**TAKE THE SAG OUT
OF YOUR SALES CURVE**

TIE-IN-CASH-IN

General Electric Company
Room 1208, 570 Lexington Avenue
New York City
Yes Sir! I'm going after this Christmas business. Please tell me how to get promotional helps.

Name.....
Firm.....
Address.....
City.....State.....RR

GENERAL  ELECTRIC

RADIO RETAILING

NOVEMBER, 1938



For the Farmer Who Only BELIEVES WHAT HE SEES

ONE lonely little flashlight cell. It runs this big radio equipped with the new low battery-drain tube long enough to demonstrate graphically that drain actually is phenomenally low.

Credit for the stunt goes to the Arto-phone Corporation of St. Louis, originating it for the purpose of quickly convincing

hard-boiled farmers who believe only what they see.

Flashlight batteries are cheap, deliver enough voltage for normal set operation on several short demos. Spectacular staging frequently proves more effective than the best sales patter.

Try it on your next battery set prospect.



NOW BAFFLES ARE LESS BAFFLING

Clever mass demonstration staged every five minutes during Marshall-Field's radio show in Chicago removed much of the mystery from good tone. Sets were played with speakers in and then out of their cabinets, sound effects piped alternately through the two tubes of a Stromberg-Carlson Labyrinth "Proving Display" and an amplifier to the fascinated audience

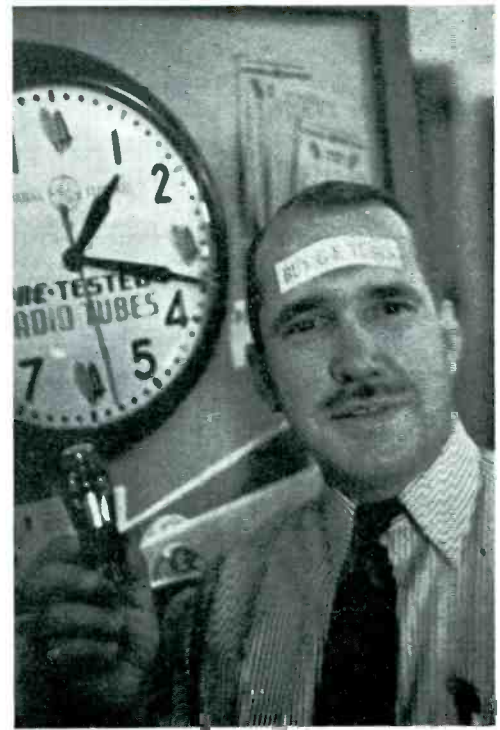

USES HIS HEAD

Dramatic signboard is the forehead of Allentown (Penna.) C.E. Supply's assistant appliance sales manager. To it during sales meetings Art Wegert sticks tabs tying in with the theme of his talk. Showmanship like this rivets the attention of the listener



PROXY CAROLER

Wide open for Christmas carols or Swiss bell-ringing as the holiday season begins are promotion-minded department stores everywhere. George H. Howell of Detroit's KLA Sound Studios (above) sells them sound equipment plus records



COMFORTRACTOR

Swank new streamlined Comfortractor (right) by Minneapolis-Moline has a cab like a pleasure car, is as much at home on the road as in the furrows, comes stock-equipped with a radio and a whip antenna

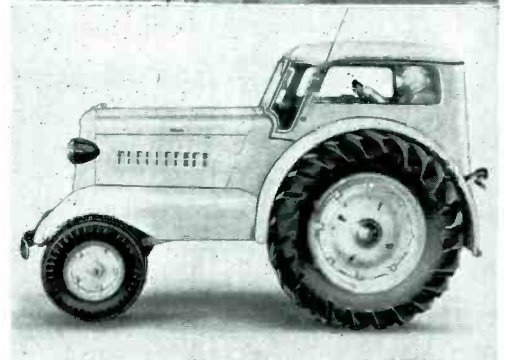



BIGGEST RADIO RETAILERS

"Biggest men in radio retailing", claim the brothers West of Long Beach (Calif.) American Radio and Sound Company. A signboard shouts it from their storefront. Salesmanager Barney, 26, weighs 312. Servicemanager Tiny, 28, weighs 414. Any disputants?

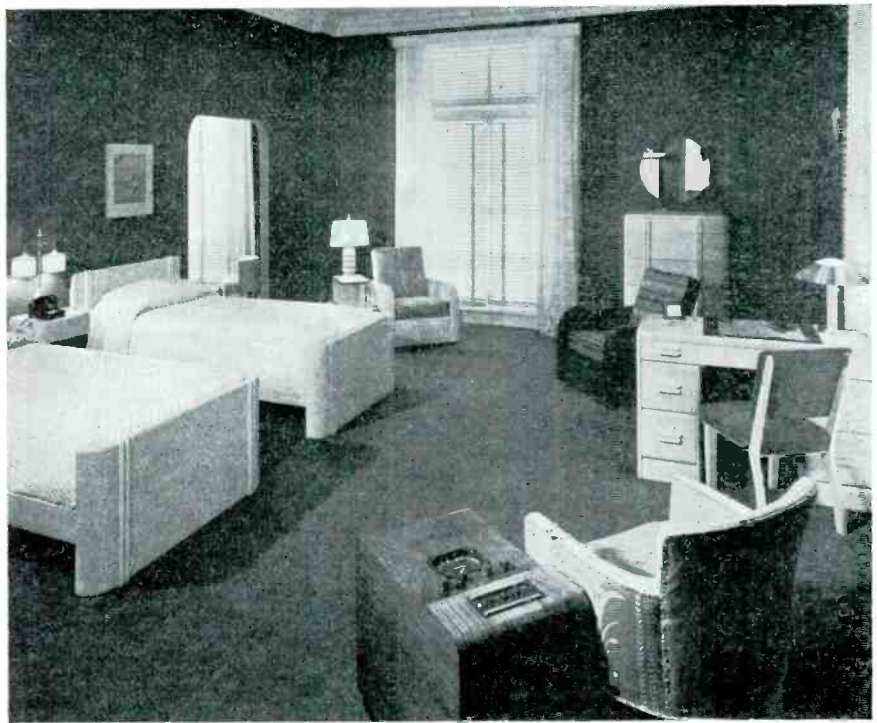

FITS LIKE A DUCK'S FOOT IN MUD

Into the decorative scheme of Los Angeles' famous Town House went a Howard receiver, fitting this room as if it had been poured into a mould. No longer just a clever electronic gadget encased by engineers in any kind of a box that would keep it from being tripped over, radio now has furniture appeal many think is undersold

EVEN WINDOWS WHERE THEY AIN'T

Complete with venetian blinds simulating windows, linoleum, is the new electric kitchen (right) installed in the Goodwin Radio Store, Milwaukee. "Sold two complete sets of appliances first week", says Jack Goodwin, who planned the corner display

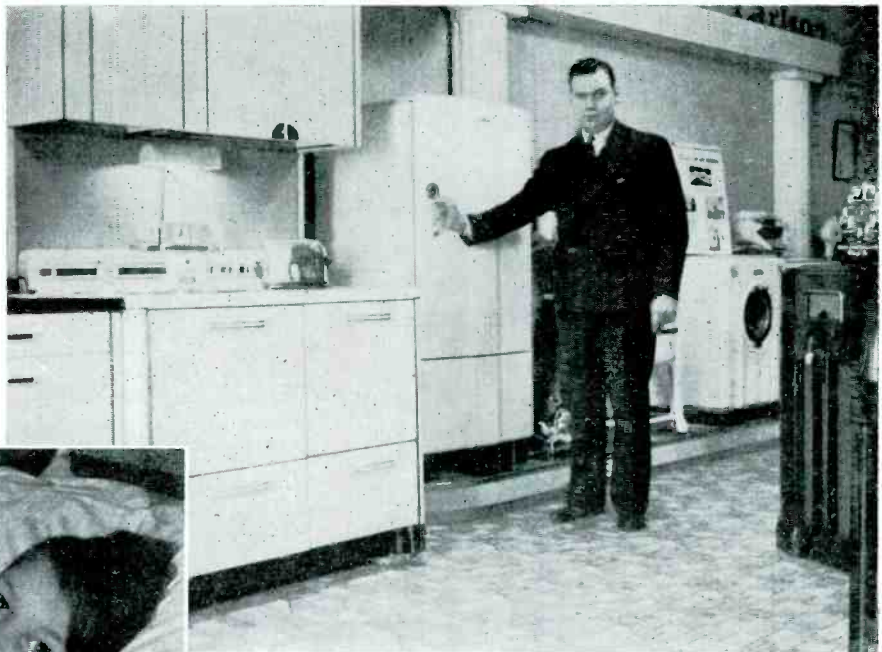

TENNESSEE JUSTICE

A better contest winner than crippled Betty Cere ALen (left) you couldn't find, where the prize is a "Charlie McCarthy" radio. She won it at the Malco Theatre in Memphis during the showing of the movie "Letter of Introduction", now is less lonely home at Jonesboro, Tennessee

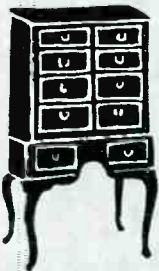
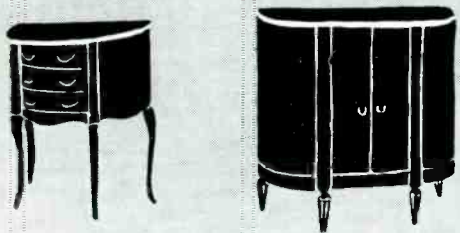

WHERE TRADITION REIGNS

..... FINE

for Holiday Radio

QUANTITY radios built into fine furniture put a double barreled weapon into the hands of the alert radio dealer with which he can bring into camp the best of the holiday gift orders.

Important in dealer's reckoning is the fact that the trend toward radios in furniture is a sugar coated way to boost unit sales and assure a better-than-average profit margin. He will spend little time with those who are "just looking". Furniture sets interest people who have well planned homes and can afford to pay for what they like.

The first requisite for successful promotion of furniture models is a line which fits into a variety of decorative schemes, and manufacturers have risen splendidly to provide it. They have designed numbers and groups that suit present day trends of interior decoration in harmony of line and color.

Since decorators no longer demand strict adherence to period or style, it is possible for the dealer to sell distinctive furniture models into a broad variety of interiors from a line of modest proportions and increase the potential rate of turnover on types of cabinet that in the past were classified as "slow moving".

Demands of radio buyers are being answered on four fronts:

1. For homes where furnishings follow traditional lines, recommend Eighteenth Century designs from Chippendale, Sheraton, Hepplewhite, or models from Queen Anne Duncan Phyfe or French tradition. Eighteenth Century sewing tables and commode end tables have never been equalled for flexibility in the way they fit into home settings, can be used to good advantage as one of a pair. Cabinets which are designed from desks, chests, highboys and lowboys often give semi-service as pieces of furniture in their own right, as well as adding to the decorative scheme and, of course, being used to house the radio chassis.

2. The smooth surfaces and broad lines of the strictly modern home call for cabinets with surfaces as smooth and lines as severe. For a home done in the modern manner, suggest pieces in distinctly modern tempo. Radios are combined to advantage with desks, bookshelves or cabinets, and contribute materially to room furnishings.

3. Maple interiors call for more maple. Styles here are varied, most of them based on the best examples of Early American cabinet work. They range from a novel corner cabinet design to spice chests or splayed foot tables which house fine receivers.

4. Bridging the gap between radio consoles as developed by the industry, and radios set in characteristic furniture models, are pieces which maintain the general outline of the radio console and serve one purpose—that of housing a receiver. Inspiration comes mainly from Eighteenth Century cabinets and chests. Recommend them for any but modern or maple settings.

The fulcrum of the lever which will pry open a customer's pocket-book and assure a successful furniture set sale lies in determining what the prospect's decorative scheme is and fitting your merchandise into that scheme.

If he shows interest in maple, he no doubt has been faced with the possibility that he will have to bring a highly polished walnut or mahogany cabinet into his carefully planned maple room, and your display of maple cased sets will probably be more than he had hoped to find. The leverage in his case is enormous. He will be glad to take whatever best suits his present layout, and will thank you for selling it to him. Should he hesitate over the color of the wood, point out to him that when smart furniture combines different colors of wood in one piece of furniture his decorative scheme can embrace some variation of wood tone, if design is sound. On the other hand should

IN MODERN TEMPO

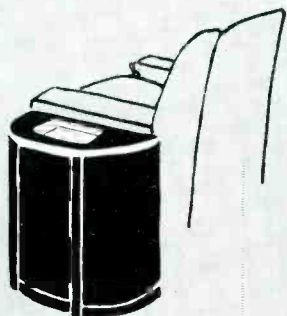
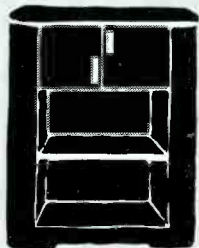
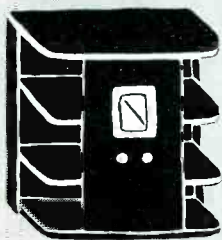

FURNITURE

Buyers

By J. H. AVELING

Drawings by the Author

he question design, match the wood tone of his furniture.

Owners of modern furniture are always aware and proud of it. They usually have chosen the newer designs because they like them and enjoy the feeling that their home is really streamlined. For that reason they are unusually susceptible to suggestion that here are radio designs, which few of their friends will duplicate. They enjoy adding

FROM STYLE HEADQUARTERS

Decorators no longer demand strict adherence to period or style . . . You can mix certain styles and still be in good taste . . . This simplifies the stock problem, creates an entirely new and important potential market.

the best set money can buy to their thoroughly up-to-date rooms.

When the customer is uncertain what his scheme of decoration is, or when he mentions definitely that his furniture is "period", traditional designs will almost always be like one or another of his pieces of furniture. The two or three drawer commode end tables can be used singly or matched and used as a pair. Duncan Phyfe tables are as popular, or more popular, than any other occasional table design and fit almost anywhere. Queen Anne is a good mixer and will fit into varied company. Most of the larger pieces have beauty of line and general utility to recommend them. A few questions will determine whether, with the line which the dealer has available, it

will be best for him to emphasize beauty of finish and wood used or harmony of design.

Dealers who have boosted store traffic, inquiries and profits by pushing furniture sets have found it wise to make some definite adjustments of sales technique. Higher priced sets in the past have been sold to a *man's* understanding of radio values—selectivity, circuit and tuning improvements, band coverage. Adjusted technique gives the dealer another peg from which to hang a successful demonstration by spot-lighting, in addition, facts which are of interest to women. The kind of reasoning which will help to add the woman's vote in making a sale points out the fact that the furniture model is adaptable; it "wears" well the more it is seen; it is livable; a big slice of the set price can be charged off to the home furnishings budget.

Characteristic of the 1939 season are offerings from manufacturers which are so particularly adapted to special uses that they create new places for themselves and intrigue the consumer into installing radio in still another place in the home. Cases in point are the novelty table sets especially adapted to the children's playroom; the miniature table models which fit into corners where radio has never gone before; clock models which may be set for times and programs; combination radio-phono models, portables which may go to the shore or mountains and operate from battery or a.c.-d.c. plug-ins.

The fine cabinet job done by the radio industry in developing the imposingly attractive lines of the 1939 radio console and chairside model is well supplemented by furniture sets. Manufacturers have been quick to realize that these sets will seldom go where a console might have gone—that the furniture set creates a place for itself on its own merits as a piece of fine furniture as well as a source of high class entertainment.

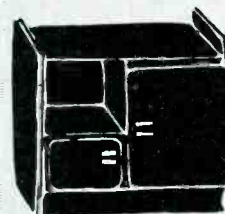
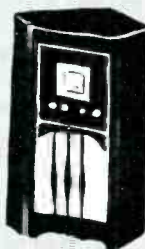
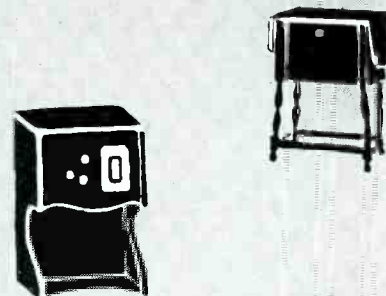

IF MAPLE IS KING

COUSIN TO THE CONSOLE

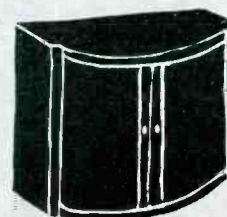
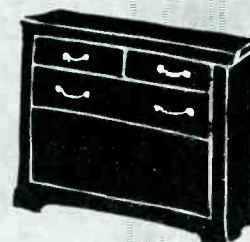
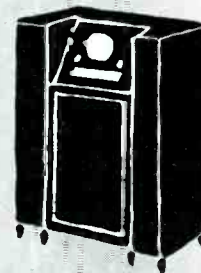

REPORT on TELEVISION

RADIO'S biggest piece of news since the beginning of commercial broadcasting (Nov. 2-1920) broke on October 20th when David Sarnoff, President of the Radio Corporation of America, announced that commercial television would be launched next year.

Specifically, Mr. Sarnoff told the Board of Directors of the Radio Manufacturers Association, assembled at the Roosevelt Hotel, New York, that by April, 1939 the National Broadcasting Co. (RCA subsidiary) would be on the air with television programs for at least two hours each week, and simultaneously the RCA Manufacturing Company (also a RCA subsidiary) will begin to market a limited number of television receivers.

The announcement has attracted nationwide attention, despite the fact that with only one television transmitting station in operation the National Broadcasting Co. at present cannot hope to serve more than the metropolitan area within a radius of perhaps 50 miles from New York's Empire State Building. (CBS's Chrysler Building station will cover the same area.)

Everywhere prospective buyers of new radio sets are wondering what the announcement may forecast. Should they buy a radio set now or "wait for television." Everywhere radio dealers are pointing out to prospects that this is just a small beginning, that high costs and limited production of transmitting equipment will prevent a rapid blanketing of the country with television broadcasts, that when, if and as a transmitter is constructed in any given area many modern radio sets may readily be hooked up to provide the audio reception in connection with a video receiver, thus protecting the consumer's investment.

With the industry at the threshold to the year's biggest selling season for radio sets, manufacturers, distributors and dealers are making every effort to minimize, or if possible eliminate, any retarding influence that the announcement may have on current business. They point out at the same time that at present no one can properly appraise the possibilities for hitherto unthought of thrills for the radio fan and profits for the industry that the future developments of television may generate.

In his epochal announcement Mr. Sarnoff said in part:

"The results of the experimental field tests of television in the New York area conducted by the RCA and its broadcasting and manufacturing units, have convinced us that television in the home is now technically feasible.

"We are aware, however, that many technical, artistic and financial problems still confront those who would establish an acceptable and regular public service of television programs to the home. These problems must be solved before a national service of network television programs can be made available to the public. Meanwhile, RCA, which has pioneered in the development of television, has made substantial progress, first in its research laboratories, and second through its field tests and experimental broadcast programs. We believe that the problems confronting this difficult and complicated art can be solved only by operating experience gained from actually serving the public in their homes. Therefore, RCA proposes to take a third step in the solution of these problems by beginning a limited program service to the public from its New York television transmitter on the Empire State Building. This transmitter will serve an area having a radius of approximately fifty miles.

"As publicly announced some time ago, RCA proposes to demonstrate television to the public at the New York World's Fair which is expected to open on April 30, 1939. The National Broadcasting Company contemplates that, by the time the fair opens, it will be on the air with television programs for at least two hours out of each week. . . .

"RCA believes that the development of its television system has now reached a stage where it is practicable to supply television receivers to satisfy the demand of the public in those localities where television transmissions are now or may become available. Therefore, it is planning to manufacture a limited quantity of television receivers which it expects to market by the time the World's Fair opens. We are informed that a number of other radio manufacturers in the United States are also preparing to manufacture and sell television receivers in such areas as may be served with television programs." * * *

Supplementing Mr. Sarnoff's statement, various angles on the situation were explained by Mr. George K. Throckmorton, president of the RCA Manufacturing Co. in a special letter addressed to RCA dealers and distributors.

In that letter Mr. Throckmorton lists certain pertinent questions and supplies answers to them, and as those answers are considered to be of paramount interest and import-

ance to all dealers and distributors we quote both questions and answers as follows:

"Question: How will Television affect Sound Broadcasting?

"Answer: Television will not supplant Sound Broadcasting. Sound Broadcasting, with its highly developed entertainment and informational services, has established itself firmly in our daily lives. It will continue to provide these services in a way which no other medium can supplant. Television, when it becomes available on a national basis (and no one can predict how many years off this may be), will provide another public service which will not conflict, but rather supplement existing services. In a sense, television will for a long time be merely an adjunct to sound broadcasting as we know it.

"Question: When can I expect Television in my territory?

"Answer: To have television in your territory, you must wait until at least one station in your area is willing to undertake the heavy financial and other responsibilities attendant upon the establishment of a regular program service to the public. These include, besides the purchase of the necessary transmitting equipment, changes in studios and the establishment of an organization capable of providing and staging a flow of programs on a reliable basis.

"Question: When Television comes, how will it affect the sale of broadcast receivers?

"Answer: There is not the slightest reason why anyone should hesitate to purchase a sound broadcast receiver, because of the advent of Television. When Television does come, there will still be a big demand for sound broadcasting receivers, not only for the complete hour-to-hour services that they offer, but because receivers purchased now may be used to provide the sound part of television, with an extra accessory providing the image reception.

"Question: What should the customer who is holding out because of Television be told?

"Answer: It should be explained that RCA Victor has already made provision for Television in many RCA receivers now on the market with the inclusion of the 'C' band, which will carry the sound part of the television transmissions. Most of the receivers coming from Camden in the future will also provide for 'C' band reception. From all indications, the type of television receiver that will be most popular from the price standpoint is one that may be used with existing receivers which have provision for 'C' band reception. Such receivers will have printed notices that they may be used for reception of Television sound. Obviously, this is a powerful sales argument to any customer who may have some hesitancy about purchasing a sound broadcast receiver because of the eventual advent of television." * * *

WHAT TO TELL THE PUBLIC . . .

Quote George K. Throckmorton, president of the RCA Manufacturing Company, whose firm puts television in the headlines by promising New Yorkers a *limited* number of receivers this Spring:

1. "Television will not supplant sound broadcasting. Sound broadcasting . . . will continue to supply . . . services in a way which no other medium can supplant
2. "To have television you must wait until at least one station in your area is willing to undertake the heavy financial and other responsibilities attendant upon the establishment of a regular program service to the public
3. "There is not the slightest reason why anyone should hesitate to purchase a sound broadcast receiver."

Although important factors in the radio industry have welcomed the arrival of commercial television as the beginning of a new era of productivity and prosperity, there are others who hold that television should have been kept in the laboratory until remaining important problems have been solved. For instance, *E. F. McDonald, Jr.*, president of *Zenith Radio Corporation*, in a letter sent to **ZENITH** stockholders on October 29th argues:

"The offering for sale of television receivers at this time in view of the present state of the art is, in my opinion, unfair to the public, and premature, both for economic and technical reasons. Such premature introduction of television commercially will result in loading the public with undue experimental replacement cost, which, in turn, will result in retarding, instead of furthering development and in unprofitable operations for the companies engaging in such a program.

"The economic problems which must be settled before the public should be asked to buy television receivers are no less serious than the technical difficulties. In the present state of the art, it is not possible to transmit a television program beyond a radius of from thirty to fifty miles, depending upon the height of the transmitting station above the ground, and even in that area buildings and other structures situated between the transmitter and the receiver make good reception extremely difficult. In other words, in order to furnish television programs to purchasers of television receiving sets throughout the United States, it will be necessary to construct more than 2,000 television transmitting stations. Even though we had this multiplicity of television transmitters, no economical means has yet been discovered to connect these

transmitting stations to make possible chain transmitting of television."

That there exists considerable difference of opinion as to the timeliness of the announcement and early prospects for television, is evidenced by statements made exclusively to *Radio Retailing* by well known set manufacturers.

We quote their telegrams verbatim:

ADMIRAL—*Ross D. Siragusa, President, Continental Radio and Television Corp.*

"The recent announcement that television will be presented to the New York public next spring I believe to be considerably premature. In discussions I have had with various retailers it has been the consensus of opinion that this announcement will definitely prove detrimental in the sale of radios especially consoles. I will be very much interested in the opinions expressed by other set manufacturers."

CROSLY—*Powel Crosley, Jr., President, Crosley Corporation.*

"Technically television has arrived. Satisfactory pictures can be transmitted up to fifty miles. It should be offered to public with a clear understanding of the program limitations. Pictures comparable to movies can be expected to only a very limited extent for years to come. Television picture production costs and who will pay them present problem that it will take years to solve. Initial cost of television receivers, service limitation to large cities, tremendous expenditures involved will definitely limit sales. It will be a great mistake to ballyhoo television to the public beyond honest statement of facts."

EMERSON—*Ben Abrams, President, Emerson Radio and Phonograph Corp.*

"My opinion is that television when finally announced will help rather than hurt the sale of sound receivers. It will once and for all give the public the long waited for opportunity to judge for themselves as to the entertainment and educational value of a television receiver as compared to a present day sound receiver. It is my firm belief that when the buying public will be afforded the opportunity of measuring the value of a television receiver from the standpoint of the type of programs and infrequency of broadcasts as will be the case next year and perhaps for some time to come, that it will result in a far greater appreciation of the present day value of sound receivers, which values there is every reason to feel will be maintained and perhaps even improved. However I am likewise of the opinion that television will come into its own commercially but not at least for about five years, and of course as television programs are improved there is reason to feel that interest in television will be increased, and if such interest in television increases there will be a corresponding decrease in the sales of sound receivers. I am optimistic over the future of sales possibilities of sound receivers, and look forward with confidence to an increase in sales from year to year at least for the next three years."

GENERAL ELECTRIC—*W.*

R. G. Baker, General Electric Co.

"General Electric has had television under development since 1927 and will continue to participate in all phases of this new art. Television has passed through two phases of development and is now apparently destined to enter the third. Late in 1935 progress in research and development had reached a point where field and propagation tests seemed justified. These tests carried on by trained personnel have probably reached a stage where the solution of contemporary problems can be more readily solved by public participation in the utilization of a limited and experimental television service."

SENTINEL—*E. Alschuler, President, Sentinel Radio Corp.*

"Realizing inevitability of television announcement believe will encourage sales of radio sets in price range less than \$150.00 providing general public fully informed television limitations and possibilities and price range of receiving equipment."

STROMBERG - CARLSON—

Geo. A. Scoville, Vice-President, Stromberg-Carlson Telephone Mfg. Co.

"While we welcome launching of television as new industry, you must help educate public quickly as to limitations, as well as possibilities of television as a means of satisfying entertainment, otherwise interest in sound broadcasting will be lessened and market for new broadcast receivers will be temporarily killed. At best, it will take long time to cover largest cities with good television programs and smaller cities and rural communities are not at present in this television picture. After television is thoroughly entrenched, it is safe to say that present type of sound broadcasting will continue to furnish majority of entertainment and information types of programs."

**345,000 People
Go to Work
...When Radio Throws
the Switch**

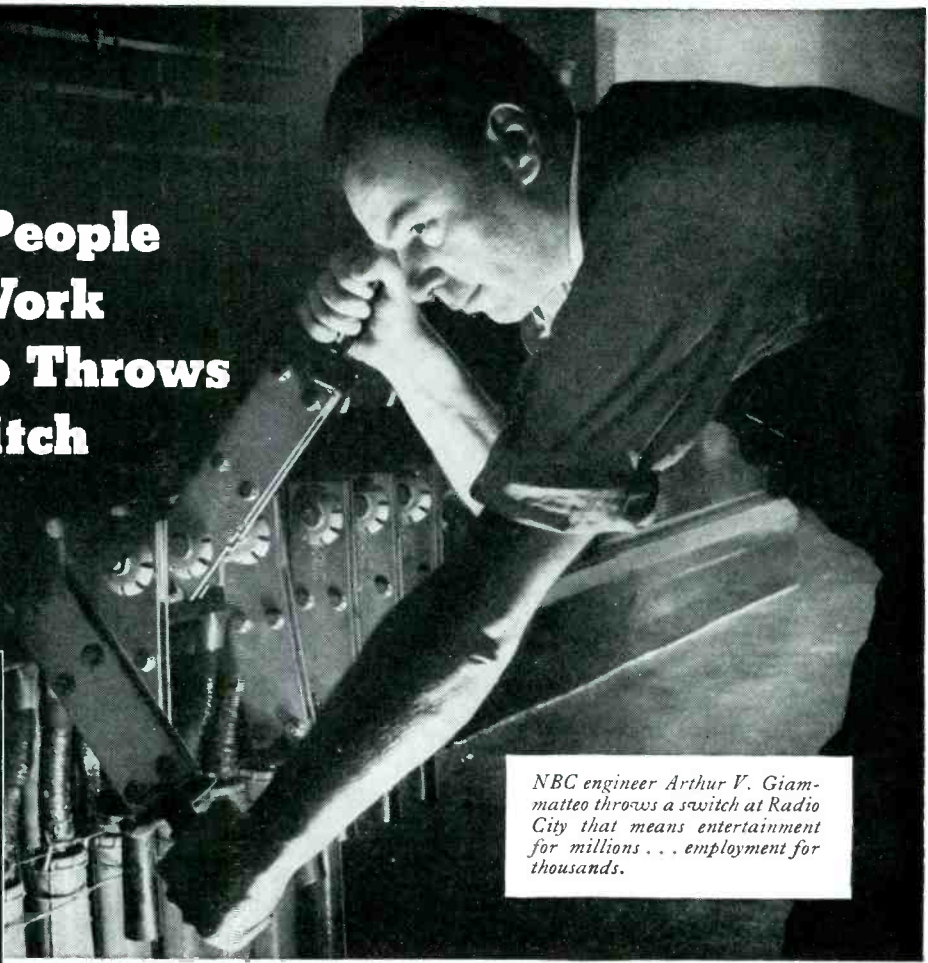

NBC engineer Arthur V. Giammatteo throws a switch at Radio City that means entertainment for millions . . . employment for thousands.



The RCA Victor Family has many long-time members. Above is Group Supervisor Bessie Purnell, who has been with Victor for 32 of its 40 years.



8,000 American radio operators on ships and ashore handle hundreds of thousands of radio messages that help business and guard lives and property. Leaders in these activities are R. C. A. Communications, Inc., and Radiomarine Corporation of America, members of the family of RCA.

TO MOST AMERICANS today radio is entertainment, news, and education . . . the greatest show on earth. But to 345,000 workers and their families . . . a total of some 1,380,000 men, women and children . . . radio is even more than a show, it is a living. Where only a few years ago radio jobs were non-existent, now 700 odd radio stations and 500 and more factories create tens of thousands of jobs.

Radio a Boon to Thousands in Wholesale and Retail Businesses

About 25,000 are connected with wholesale establishments handling

radio merchandise. Retail radio merchants account for 56,000 and salesmen, service men, and others engaged in radio sales and service number 150,000.

For retailers and wholesalers as well as for the 19,000 members of its own organization, the Radio Corporation of America works aggressively to bring ever increasing prosperity by constantly improving the services radio gives the public. America has come to recognize the advantages in going "RCA ALL THE WAY." As a result . . . there is an ever richer field of opportunity for merchants who go RCA All The Way, too.

Listen to the "Magic Key of RCA" every Sunday, 2 to 3 P. M., E. S. T., on the NBC Blue Network.

RADIO CORPORATION OF AMERICA

RADIO CITY, N. Y.

RCA MANUFACTURING CO., INC.	RCA INSTITUTES, INC.	R. C. A. COMMUNICATIONS, INC.
RADIOMARINE CORPORATION OF AMERICA	NATIONAL BROADCASTING COMPANY	

More DOLLARS Per SALE

**COMBINATIONS,
RECORD-PLAYERS
and RECORDS
Offer These
5 Advantages:**

CLASSICS

when wanted

CONTINUOUS

swing music

OLD FAVORITES

uninterrupted

INSPIRATIONAL

themes

EDUCATIONAL

aids

ON the road to an alltime high are record sales, once believed by many to have been wiped out as a major home entertainment medium with the introduction of radio.

Retaining its original and unique advantage . . . ability to provide what the listener wants when he wants it . . . the disc has been immeasurably aided by many of the very happenings that put it temporarily on the shelf. Electrical reproduction through the use of tubes imparts to recordings tone quality and volume originally lacking. The very speed with which radio brings new tune hits to the listener faster than he can obtain them on wax now wears them out

as microphone fodder before many fans have had enough. Necessity of catering to the masses when broadcasting sponsored programs, leaves a gap now adequately filled only by records in the ranks of smaller but financially potent groups more critical in their entertainment requirements than the average.

Higher unit sales, inherent ability to bring customers back again and again for exposure to new mer-

chandise, close alliance in appearance and function and market with receivers that tap the airplanes . . . these are a few of the things which make record-players and phonocombinations one of the best bets for radio dealers to whom such advantages are becoming more and more vital.

Records . . . plus machines on which to play them . . . are a "must" for 1939.

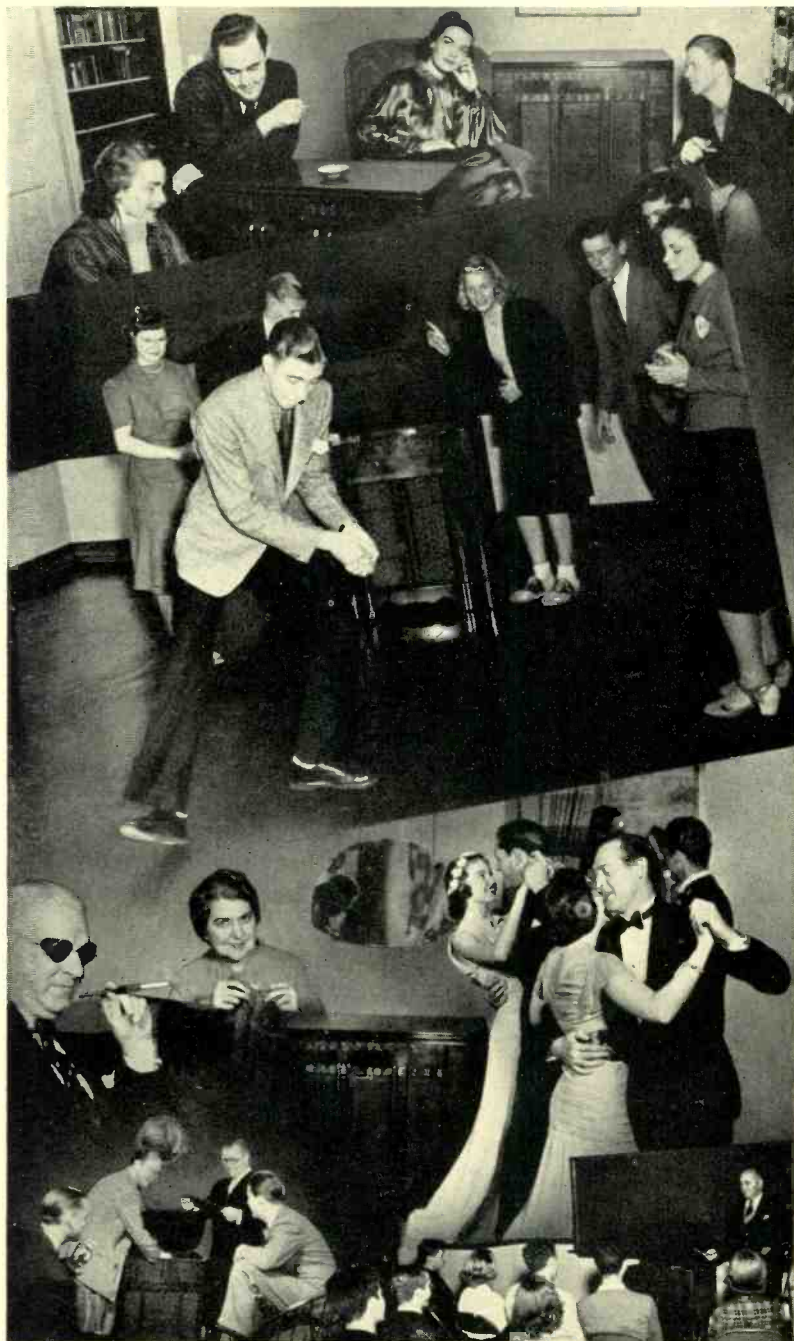

RECORDS Sprint for the

By

RICHARD GILBERT

IF you want a symbol to peg on the sensational revival of the record and phonograph business—a spurt that shows no sign of subsiding—you will find it in that familiar little box with a felt-covered disc and pickup called a record player. The hypodermic, first injected a few years ago, took effect slowly, but during the past ten months the glandular reaction has been terrific. The patient, gentlemen, is not only alive and kicking, he is strutting a virility that is phenomenal.

Record players and records have become so popular that they are being offered as premiums in newspaper circulation build-ups. Symphonies and turntables are now the prize in place of Websters' and the Complete Works of Victor Hugo. Early in October, *The New York Post* courted the cultural aspirations of several hundred thousand subway riders with full page ads featuring the works of Bach, Brahms, and Beethoven, and a handy coupon. The results of the *Post's* special inducement, up to the time of writing, have been so favorable that the idea seems certain to be used in other cities.

Something People Want

People won't buy papers and clip coupons for something they don't want.

There you have the idea back of the symbol. The real reason is that people want recorded music. The *Post* circulation plan is based on this demand. Incidentally, the publicity attendant on such independent promotion—despite some dealers' qualms to the contrary—is invaluable in stimulating interest in recorded music. The more turntables you get into the homes of the nation, the greater the desire for more records, and the greater



the opportunity for you to cash in on a *repeat* business.

Turntables are being planted everywhere. One manufacturer has a bargain offer, now in its ninth highly successful month, of a player, nine dollars worth of records, and a year's subscription to a monthly illustrated record review. The last has proved effective propaganda for the repeat business. Other manufacturers have brought out a variety of record players, some of which make use of the phonograph jacks incorporated in practically every new radio, while others need no connecting wires—just plug into the house current and tune your radio to grooved sound.

If present statistics are reliable, turntables are going into homes where records haven't appeared for years at the rate of 2500 per week.

It's too early to get facts from the manufacturers of the wireless jobs, and some of the smaller companies' record player business is mainly local. RCA Victor reports that more record players were sold during the first four months of this year than during the twelve months of 1937. Since late summer, memberships in the Victor Record Society, the greater percentage of which are derived from record player purchases, have been coming in at the

UNBEATABLE TEAMWORK

People with old phonographs buy new electrically recorded discs, so good they show up imperfections in obsolete machines. Back comes the customer later for a new record-player to work with his present radio, in turn eventually replaced by a better set or phono-combination. Then the cycle starts all over again when the customer returns for more records.

rate of 2000 each week, and this figure is constantly increasing as the fall season gets into swing.

Radio manufacturers aren't ignoring the combination line. To the contrary, every company is plugging phonographs this year, and the public is swimming towards the bait of a two-in-one buy, mainly on account of the wide variety of models offered, and the sensationally low list prices. Automatic record changing instruments have been brought within reach of modest pocketbooks for the first time since the special mechanism has been offered.

Easy Step Sell-Up

The alert dealer is aware that many of his best combination prospects are those very purchasers of record players who have become ad-

GOALPOSTS

dicted to collecting platters, whether of swing or symphony, and hanker for the brilliant reproduction the new jobs provide. Don't forget that the science of recording has progressed by leaps and bounds during the past few years, and that many present users of record players are piping wide-range music into obsolete or near-obsolete radios that cannot bring out the full quality of the recording. The initial cost of the player wasn't great, and the desire to acquire a better reproducer for records already purchased is yours to nourish. Be sure that your customer, with a record player at home, hears a demonstration of new discs on an



up-to-the-minute combination in your store.

The point that a record player sale is simply a beginning can't be over-emphasized. And, as the record player promotion appears to be the nucleus around which much of this remarkable interest in recorded music is based, it pays to see that the pickup is properly matched

Fast-moving discs provide irresistible interference, open field for new record-players and phono-radio combinations

to the customer's radio. A bad connection here may result in a prospective record collector's dissatisfaction with recorded music. See that the installation is a definite follow-up service. The good-will you establish at the very beginning pays dividends when new records are desired or a better reproducer contemplated.

575 Percent Gain

Increase in record sales—particularly during the slack period of several months ago—has been remarkably high. Sales figures have jumped 575% ahead of 1933, and it would be a safe estimate to say that this year's increase over 1937 will be in excess of 20%.

Classical record sales and album sets continue to forge ahead. More listeners have become "library" conscious. Fine broadcast programs like the Toscanini concerts have stimulated a keen desire for more music of the masters among people who formerly considered the classics "high brow" or "over their heads." These neophytes wind up, sooner or later, at the disc counter.

Popular record business has pulled up tremendously during recent months. This has been due largely to the "swing" fad and the record player. The latter's low price, the existence of a radio in practically every home, and the enthusiasm of the adolescent jitterbug for the Dorseys, Crosbys, Goodmans, Wallers and Basies of the land account for the presence of records in hundreds of thousands of homes.

35-Centers Too

The thirty-five cent popular disc is also an important factor. These low priced records have established thousands of new accounts. In this field Decca has set a sizzling

pace, offering a fine array of dance bands and vocalists, and an attractive series of brightly colored albums featuring various types of salon music—Strauss, Lehar, Kalman, and Waldteufel waltzes, Russian and Hungarian Gypsy tunes, songs of Stephen Foster, etc.—as well as special tango, rhumba, and Hawaiian collections which, at \$2.25 per album of five discs, is more than a decoration to any counter. Decca also has a classical catalog, repressings of European recordings (mostly of ten and a half-dozen years ago), of discs at .75¢ and .50¢ list. This company is currently getting behind a line of four acoustic portables, and an electric table model phonograph.

Also in the thirty-five-cent record field is Victor, this month wheeling the big guns of a nation-wide promotion behind its Bluebird label, announcing a straight 40% discount with a 5% return privilege, and adding to its list of artists such bands as those of Artie Shaw, Erskine Hawkins, Eddie De Lange, "Fats" Waller, Glen Miller, and Les Brown, and vocalist Dick Todd. After two weeks of special promotion Bluebird sales throughout the country doubled.

The American Record Company labels—Vocalion, Brunswick and Columbia announce large increases in sales. European affiliations supply most of the matrices for Columbia pressings.

Well, that's the band wagon. The knowing dealer will climb aboard now, or his nearest competitor will have left him far behind soon. Things being as they are, your observer is somewhat puffed with pride. For more than five years, off and on, in the pages of *Radio Retailing* he's been saying, "Just wait and see."

And now's the time to look.

RECORD PLAYERS

Pickup-turntable units designed to work through any radio amplifier, complete

PRICE NUMBER	MODEL	Type	MOTOR						Number Tubes	Built-in Amplifier
			Type Pickup	Speed	AC or DC?	Maximum Record Size (inches)	Number Records Held	Portable?		
AIR KING PRODUCTS CO., 1523 63 St., Brooklyn, N. Y. AIR KING										
..... 908	PC	M	78	AC	12	1	Yes	4	Yes	
..... 909	PC	M	78	AC	12	1	Yes	5	Yes	
ANDREA RADIO CORP., Woodside, Long Island, N. Y. ANDREA										
\$149.50	6-E-6	PC	C or M	78	AC	12	1	No	Yes	
149.50	634	PC	C or M	78	AC-DC	12	1	No	Yes	
184.50	8-E-8	PC	C or M	78	AC	12	1	No	Yes	
199.50	8-E-11	PC	C or M	78	AC	12	1	No	Yes	
199.50	1536	PC	C or M	78	AC-DC	12	1	No	Yes	
219.50	10-E-8	APC	C or M	78	AC	12	8	No	Yes	
239.50	10-E-11	APC	C or M	78	AC	12	8	No	Yes	
232.50	1538	APC	C or M	78	AC-DC	12	8	No	Yes	
ANSLEY RADIO CORP., 240 W. 23rd St., N. Y. C. ANSLEY DYNAPHONE										
\$69.50	D-1	RP	C	78-33	AC-DC	12	8	Yes	6	
69.50	D-1-A	RP	C	78-33	AC-DC	12	1	No	6	
79.50	D 9	PC	C	78-33	AC-DC	12	8	Yes	7	
84.50	D 10	PC	C	78-33	AC-DC	12	1	No	7	
110.00	D 12	RP	C	78-33	AC-DC	16	4	Yes	6	
115.00	D 16	RP	C	78-33	*AC-DC	12	1	No	6	
140.00	D 17	PC	C	78-33	AC-DC	12	1	No	7	
190.00	D 18	APC	C	78-33	AC-DC	12	1	No	7	
165.00	D 20	ARP	C	78-33	AC-DC	12	1	No	6	
170.00	D 21	PC	C	78-33	AC-DC	12	1	No	13	
220.00	D 22	APC	C	78-33	AC-DC	12	1	No	13	
115.00	D 23	PC	C	78-33	AC-DC	12	1	No	7	
255.00	D 24	APC	C	78-33	AC-DC	12	1	No	15	
205.00	D 25	PC	C	78-33	AC-DC	12	1	No	15	
44.50	D 26	RP	C	78-33	AC-DC	12	1	No	3	
120.00	D 27	APT	C	78-33	AC-DC	12	1	No	No	
34.50	DA	PT	C	78-33	AC-DC	12	1	No	No	
* Straight a.c. optional.										
BELMONT RADIO CORP., 1257 Fullerton Ave., Chicago, Ill. BELMONT										
..... 632	PC	C	78	AC	12	1	No	6	Yes	
..... 634	PC	C	78	AC	12	1	No	6	Yes	
CONTINENTAL RADIO & TELEV. CORP., 3800 Cortland St., Chicago, Ill. ADMIRAL										
..... 520-5C	PT	C	78	AC	12	1	Yes	5	Yes	
..... 520-5F	PT	C	78	AC	12	1	Yes	5	Yes	
..... 521-5C	PT	C	78	AC	12	1	Yes	5	Yes	
..... 521-5F	PT	C	78	AC	12	1	Yes	5	Yes	
..... 510-6B	PT	C	78	AC	12	1	Yes	6	Yes	
..... 549-6G	PT	C	78	AC	12	1	No	6	Yes	
..... 142-8A	PT	C	78	AC	12	12	Yes	8	Yes	
..... 144-11A	PT	C	78	AC	12	12	Yes	11	Yes	
..... 144-16S	PT	C	78	AC	12	12	Yes	16	Yes	
..... AW-11*	RP	C	78	AC	12	..	Yes	2	Yes	
* Wireless type.										
CROSLY RADIO CORP., Cincinnati, Ohio CROSLY										
\$9.99	488	PT	M	78	AC	12	1	Yes	No	
24.99	448	PC	M	78	AC	12	10	Yes	4	
49.99	438	PC	M	78	AC	12	15	No	4	
59.99	668	PC	M	78	AC	12	15	No	6	
DETROLA CORP., 1501 Beard Ave., Detroit, Mich. DETROLA										
\$79.50	258PC	PC	C	78	AC	12	1	No	7	
99.50	258EPC	PC	C	78	AC	12	1	No	8	
129.50	259EPC	PC	C	78	AC	12	1	No	10	
..... 208	PC	C	78	AC	12	..	No	..	Yes	
..... 228	PC	C	78	AC	12	..	No	..	Yes	
..... 233AP	PC	C	78	AC	12	..	No	..	Yes	
..... 235	PC	C	78	AC	12	..	No	..	Yes	
EMERSON RADIO & PHONOGRAPH CORP., 111 Eighth Ave., N. Y. C. EMERSON										
\$19.95	BM-216	PC	C	78	AC	12	1	No	5	
29.95	AX-219	PC	C	78	AC	12	1	No	5	
44.95	AX-221*	PC	C	78	AC	12	1	No	5	
59.95	BL-220	PC	C	78	AC	12	1	No	5	
69.95	BJ-220	PC	C	78	AC-DC	12	1	No	6	
69.95	BL-218	PC	C	78	AC	12	1	No	5	
79.95	BJ-218	PC	C	78	AC-DC	12	1	No	6	
59.95	AX-222	PC	C	78	AC-DC	12	8	Yes	5	

PRICE NUMBER	MODEL	Type	MOTOR						Number Tubes	Built-in Amplifier
			Type Pickup	Speed	AC or DC	Maximum Record Size (inches)	Number Records Held	Portable?		
99.95	AX-232	APC	C	78	AC	12	8	Yes	5	
109.95	AX-232*	APC	C	78	AC-DC	12	8	Yes	5	
129.95	BQ-223	PC	C	78	AC	12	8	No	6	
169.95	BR-224	PC	C	78	AC	12	8	No	13	
219.95	BR-224A	APC	C	78	AC	12	8	No	13	

* Available in ac-dc at slightly higher cost.

FADA RADIO & ELECTRIC CO., 30-20 Thomson Ave., Long Island City, N. Y. FADA									
\$69.95	451PT	PC	C	78	AC	12	1	No	5
79.95	461PT	PC	C	78	AC	12	1	No	6
99.95	465PC	PC	C	78	AC	12	1	No	6
89.95	465PT	PC	C	78	AC	12	1	No	6
79.95	465PF	PC	C	78	AC	12	1	Yes	6
149.50	465APC	APC	C	78	AC	12	8	No	6
109.95	470PC	PC	C	78	AC-DC	12	1	No	7
99.95	470PT	PC	C	78	AC-DC	12	1	No	7
89.95	470PF	PC	C	78	AC	12	1	Yes	7
159.95	470APC	APC	C	78	AC-DC	12	8	No	7
40.95	554PT	PC	C	78	AC	12	1	No	5
39.95	560PT	PC	C	78	AC	12	1	No	6
229.50	6A80-APC	APC	C	78-33	AC	12	8	No	8

GALVIN MFG. CORP., 4545 Augusta Blvd., Chicago, Ill. MOTOROLA

\$39.95	59F1	PC	C	78	AC	12	1	No	5
---------	------	----	---	----	----	----	---	----	---

GENERAL ELECTRIC COMPANY, Bridgeport, Conn. GENERAL ELECTRIC RADIO

\$139.95	RG-68	PC	C	78	AC	12	1	No	6
185.00	RG-69	APC	C	78	AC	12	8	No	6

GILFILLAN BROS., INC., 1815 Venice Blvd., Los Angeles, Calif. GILFILLAN

.....	SPR	ARP	C	78	AC	12	8	No	8
.....	6PR	PC	C	78	AC	12	1	Yes	6

HARDRAY, INC., 524 West Broadway, New York, N. Y. HARDRAY

\$150.00	A	APT	C, M	78	AC	10	20	No	..
----------	---	-----	------	----	----	----	----	----	----

HARRIS MFG. CO., 2422 W. 7 St., Los Angeles, Calif. HARRIS ELECTROTONE

\$52.50	45	RP	C	78	AC	12	6	Yes	4
55.00	50	RP	C	78	AC	12	1	Yes	4
79.50	100	RP	C	78	AC	12	8	Yes	4
149.50	900	APC	C	33-78	AC	12	1	Yes	8
174.50	1000	APC	C	33-78	AC-DC	12	1	Yes	8

MAGNAVOX CO., INC., 2131 Bueter Road, Ft. Wayne, Ind. MAGNAVOX

\$39.95	2A	RP	C	78	AC	12	1	Yes	3
49.95	V2A	RP	C	78	AC-DC	12	1	Yes	4
69.50	3	RP	C	78	AC	12	1	Yes	..
79.50	V3	RP	C	78	AC-DC	12	1	Yes	..
89.50	31D	PC	C	78	AC	12	1	Yes	6
98.50	V31	PC	C	78	AC-DC	12	1	Yes	7
124.50	32B	PC	C	78	AC	12	1	No	6
139.50	V32	PC	C	78	AC-DC	12	1	No	7
145.00	38	PC	C	78	AC	12	1	No	8
198.50	38B	APC	C	78	AC	12	8	No	6
225.00	V38B	APC	C	78	AC-DC	12	8	No	7
245.00	34D	APC	C	78	AC	12	8	No	8
249.50	V34E	APC	C	78	AC-DC	12	8	No	8
275.00	34E	APC	C	78	AC	12	8	No	8
475.00	35A	APC	C	78	AC	12	8	No	13

MAJESTIC RADIO & TELEVISION CORP., 2600 W. 50 St., Chicago, Ill. MAJESTIC

\$29.95	619P	PC	C	78	AC-DC	12	1	No	6
39.95	519P	PC	C	78	AC	12	1	No	5
89.95	699P	PC	C	78	AC	12	1	No	6

NOBLITT-SPARKS INDUSTRIES, Columbus, Indiana ARVIN

\$99.95	848CS	PC	C	78	AC	12	1	No	8
39.95	88	PC	C	78	AC	12	1	No	5

PHONOGRAPH WITH PHILCO, Olden & Bruening, Trenton, N. J. PHONOGRAPH WITH PHILCO

\$25.00	10RP	PT	C	78	AC	12	1	No	..
49.95	12TP	PC	C	78	AC	12	1	No	5
79.50	19TP	PC	C	78	AC	12	1	No	5
89.50	19PCS	PC	C	78	AC	12	1	No	5

to fit the PURSE

phonographs, phono-radio combinations. Including "Wireless" Types

PRICE	MODEL NUMBER	Type	Type Pickup	MOTOR				Number Tubes	Built-in Amplifier	
				Speed	AC or DC?	Maximum Record Size (inches)	Number Records Held			
99.50	19PF	PC	C	78	AC	12	1	No	5	Yes
139.50	19PA	APC	C	78	AC	12	8	No	5	Yes
225.00	30PCX	APC	C	78	AC	12	10	No	5	Yes
259.50	40PCX	APC	C	78	AC	12	10	No	8	Yes
395.00	116PCX	APC	C	78	AC	12	10	No	14	Yes
PIERCE AIRO, INC., 440 Lafayette St., New York, N. Y. DE WALD										
399.95	531	PC	C	78	AC	12	1	No	5	Yes
49.95	532	PC	C	78	AC-DC	12	1	No	8	Yes
42.50	536	PC	C	78	AC	12	1	Yes	5	Yes
52.50	537	PC	C	78	AC-DC	12	1	No	8	Yes
49.95	653	PC	C	78	AC	12	1	No	6	Yes
59.95	654	PC	C	78	AC-DC	12	1	No	9	Yes
111.50	645C	PC	C	78	AC-DC	14	1	No	6	Yes
117.95	648C	PC	C	78	AC-DC	14	1	No	7	Yes
109.95	649C	PC	C	78	AC	14	1	No	6	Yes
119.95	650C	PC	C	78	AC-DC	14	1	No	7	Yes
111.95	651C	PC	C	78	AC	14	1	No	6	Yes
154.95	1002C	PC	C	78	AC	14	1	No	10	Yes
158.95	1003C	PC	C	78	AC	14	1	No	10	Yes
158.95	1004C	PC	C	78	AC	14	1	No	10	Yes
164.95	1104C	PC	C	78	AC-DC	14	1	No	11	Yes
168.95	1105C	PC	C	78	AC-DC	14	1	No	11	Yes
168.95	1106C	PC	C	78	AC-DC	14	1	No	11	Yes
PILOT RADIO CORP., 3706-36 St., Long Island City, N. Y. PILOT										
399.50	TP423	PC	C	78	AC-DC	12	1	No	7	Yes
139.50	PH554	PC	C	78-33	AC	12	1	No	5	Yes
139.50	PH454	PC	C	78-33	AC-DC	12	1	No	6	Yes
139.50	QH554	PC	C	78-33	AC	12	1	No	5	Yes
139.50	QH454	PC	C	78-33	AC-DC	12	1	No	6	Yes
149.50	QG184	PC	C	78-33	AC-DC	12	1	No	8	Yes
149.50	PH664	PC	C	78-33	AC	12	1	No	6	Yes
149.50	PH474	PC	C	78-33	AC-DC	12	1	No	7	Yes
149.50	QH664	PC	C	78-33	AC	12	1	No	6	Yes
149.50	QH474	PC	C	78-33	AC-DC	12	1	No	7	Yes
159.50	RH554	PC	C	78-33	AC	12	1	No	5	Yes
159.50	RH454	PC	C	78-33	AC-DC	12	1	No	6	Yes
164.50	PH874	PC	C	78-33	AC	12	1	No	7	Yes
164.50	PH484	PC	C	78-33	AC-DC	12	1	No	8	Yes
164.50	QH874	PC	C	78-33	AC	12	1	No	7	Yes
164.50	QH484	PC	C	78-33	AC-DC	12	1	No	8	Yes
169.50	RG184	PC	C	78-33	AC-DC	12	1	No	8	Yes
194.50	QX304	PC	C	78-33	AC-DC	12	1	No	11	Yes
219.50	SH664	APC	C	78	AC	12	8	No	6	Yes
219.50	SH474	APC	C	78	AC-DC	12	8	No	7	Yes
234.50	SH874	APC	C	78	AC	12	8	No	7	Yes
234.50	SH484	APC	C	78	AC-DC	12	8	No	8	Yes
239.50	RX304	APC	C	78	AC-DC	12	8	No	11	Yes
239.50	RH874	APC	C	78	AC	12	8	No	7	Yes
249.50	RH484	APC	C	78	AC-DC	12	8	No	8	Yes
275.00	PG528	APC	C	78	AC	12	8	No	12	Yes
RCA MFG. CO., INC., Camden, N. J. RCA-VICTROLA										
\$19.95	U-104	PC	C	78	AC	12	1	Yes	5	Yes
39.95	U-112	PC	C	78	AC	12	1	Yes	5	Yes
59.95	U-115	PC	C	78	AC	12	1	Yes	6	Yes
79.95	U-119	PC	C	78	AC	12	1	Yes	6	Yes
99.95	U-122E	PC	C	78	AC	12	1	No	6	Yes
99.95	UY-122E	PC	C	78	AC-DC	12	1	No	7	Yes
99.95	U-124	PC	C	78	AC	12	1	No	6	Yes
99.95	UY-124	PC	C	78	AC-DC	12	1	No	7	Yes
175.00	U-125	APC	C	78	AC	12	8	No	8	Yes
185.00	U-128	APC	C	78	AC	12	8	No	10	Yes
230.00	U-130	APC	C	78	AC	12	8	No	12	Yes
280.00	U-132	APC	C	78	AC	12	8	No	14	Yes
355.00	U-134A	APC	C	78	AC	12	8	No	16	Yes
365.00	U-134A†	APC	C	78	AC	12	8	No	16	Yes
24.50	R89	RP	C	78	AC	12	1	Yes	3	Yes
32.95	R91	RP	C	78	AC	12	1	Yes	4	Yes
14.95	R93C	PT	C	78	AC	12	1	Yes	..	No
32.50	R94B	PT	C	78	AC	12	1	Yes	..	No
..	R93B	PT	C	78	AC	12	1	Yes	..	No
12.50	O-12	*	..	78	..	12	1	Yes	..	No

* Spring type.
† Mahogany.

PRICE	MODEL NUMBER	Type	Type Pickup	MOTOR				Number Tubes	Built-in Amplifier	
				Speed	AC or DC?	Maximum Record Size (inches)	Number Records Held			
RECOTON CORPORATION, 178 Prince Street, New York, N. Y. RECOTON										
\$29.95	Jr	PT	C	78	AC	12	1	No
35.95	Jr	PT	C	78	AC-DC	12	1	No
32.95	Master	PT	C	78	AC	12	1	No
39.95	Master	PT	C	78	AC-DC	12	1	No
SONORA ELEC. PHON. CO., INC., 132 West 22nd St., New York, N. Y. SONORA										
\$16.75	PBS	PT	M	78	AC*	12	1	No	..	No
18.00	PBSC	PT	C	78	AC*	12	1	No	..	No
24.95	PBW	PT†	C	78	AC*	12	1	No	2	Yes
24.95	PB1	PT	C	78	AC*	12	1	No	..	No
29.95	PB1W	PT†	C	78	AC*	12	1	No	2	Yes
24.95	PB3	PT	C	78	AC*	12	1	Yes	..	No
29.95	PB3W	PT†	C	78	AC*	12	1	Yes	2	Yes
44.95	PT-600	RP	C	78	AC	12	1	No	4	Yes
59.95	P-800	RP	C	78	AC	12	1	No	5	Yes
* All Models except PT-600 and P-800 may be had in AC-DC at a small additional charge. † Wireless.										
SPARKS WITHINGTON CO., Jackson, Mich. SPARTON										
\$24.95	219P	PT*	C	78	AC	12	1	..	3	No
29.95	219PD	PT*	C	78	AC	12	1	Yes	3	No
250.00	1288P	APC	M	78-33	AC	12	10	No	12	Yes
* Wireless.										
STEWART-WARNER CORP., 1826-1852 Diversey Pkwy., Chicago, Ill. STEWART-WARNER										
..	91-649	PC	C	78	AC	12	1	No	6	Yes
STROMBERG-CARLSON TEL. MFG. CO., Rochester, N. Y. STROMBERG-CARLSON										
..	336P	PC	C	78	AC	12	1	No	7	Yes
..	340P	PC	C	78	AC	12	1	No	9	Yes
..	341P	PC	C	78	AC	12	8	No	9	Yes
..	350P	PC	C	78	AC	12	8	No	11	Yes
..	280P	PC	C	78	AC	12	15	No	16	Yes
..	11	PT	C	78	AC	12	1	Yes	..	No
TROY RADIO & TELEVISION CO., 1144 So. Olive St., Los Angeles, Calif. TROY										
\$39.95	P-51	PC	C	78	AC	12	1	No	5	..
49.95	P-626	PC	C	78	AC	12	1	No	6	..
39.95	58PC	PC	C	78	AC	12	1	No	7	..
119.50	170PC	PC	C	78	AC	12	1	No	7	..
149.50	170PC	ARP	C	78	AC	12	8	No	7	..
99.50	CS736	PC	C	78	AC	12	1	No	7	..
139.50	CS736	ARP	C	78	AC	12	8	No	7	..
24.95	400	PT	C	78	AC	12	1	No
46.50	401	RP	C	78	AC	12	1	No	3	..
WESTINGHOUSE ELEC. SUPPLY CO., 150 Varick St., New York, N. Y. WESTINGHOUSE										
..	WR472	PC	C	78	AC	12	1	No	5	Yes
..	WR-472A	PC	C	78	AC	12	1	No	5	Yes
WILCOX-GAY CORPORATION, Charlotte, Michigan. WILCOX-GAY										
\$19.95	A-56	PT*	C	78	AC	12	1	Yes	2	No
29.95	A-57	PT*	C	78	AC	12	1	Yes	2	No
* Wireless.										
ZENITH RADIO CORP., Chicago, Ill. ZENITH										
\$29.95	6-D-302	PC	C	78	AC-DC	12	1	No	6	Yes
44.95	5-R-303	PC	C	78	AC	12	1	No	5	Yes
79.95	6-S-304	PC	C	78	AC	12	1	No	6	Yes
99.95	6-S-301	PC	C	78	AC	12	1	No	6	Yes
99.95	6-S-305	PC	C	78	AC	12	1	No	6	Yes
149.95	6-S-306	APC	C	78	AC	12	8	No	6	Yes
199.95	9-S-307	APC	C	78	AC	12	8	No	9	Yes
350.00	15-S-303	APC	C	78	AC	12	8	No	15	Yes
44.95	S6416	PT	C	78	AC	12	1	No
49.95	S6622	PT	C	78	AC	12	1	No

PT = Pickup-Turntable Unit
RP = Complete Record Player (Self Contained)
PC = Radio Phono Combination
APC = ARP = Automatic type

C = Crystal
M = Magnetic

The music you want, served when you want it, is booming phone-radio combination and record-player sales

By TOM
BLACKBURN

Dinner MUSIC at 8



AT the turn of the twenties, wrinkled, wise old Julius Rosenthal, who ran a mail-order watch business into many millions for the Sears Roebuck institution, said to your correspondent, "It's the repeat business that counts, my boy—you get it with almost no sales cost."

Beckoning to radio dealers for a dozen years has been the will o' the wisp business, a promise of easy garnered repeat profits.

But—Just as the automobile sedan a dozen years ago cost double the price of an open car—with nothing additional but four doors and some windows—so did the radio record player fetch a rattling jolt to the pocketbook of anyone with the temerity to ask for one.

Turn of the wheel, as novelists like to say, came when they started making low priced sets so doggoned good. The phonograph combination offered a possible handle with which to trade up prospects to higher priced merchandise. Manufacturers saw the light, produced merchandise which was in line.

Among those who jumped into activity were Jim Earl of Woodlawn Radio, Chicago. He is one of the leaders in volume on this business.

"Find out the prospect's favorite radio program," he advises, "Ask him if he wouldn't prefer listening

to several hours of that kind of music instead of to run-of-mine programs. He would. Inasmuch as he's getting a radio for pleasure, wouldn't he like concentrated double-dyed quintessence of pleasure of this sort. Of course. A record player is the answer."

"Hey, I've already got a stack of records and an old phonograph down in the basement," comes back Mr. Prospect.

"Mister, time marches on in the record business, just as it does with automobiles," replies Mr. Earl. "Those old records in your basement are obsolete. Listen here, and you'll hear something new."

Thus follows a demonstration. Oddly enough, the public lays down the gilt on the mahogany when it buys records, where it has been taught to buy radios on time. And cash in the till is welcome to radio men these days, says Jim Earl.

According to Miss Pearl Brunswick, Chicago distributor saleswoman, the record franchise is growing in popularity. Five years ago there were only ten in greater Chicago, today there are seventy.

Says Frank J. Hassmer, grizzled veteran record man with a Chicago distributorship: "80 per cent of the Victor records sold today are Red Seal, whereas only 10 per cent were

this quality a dozen winters ago. Fully 60 per cent of the platters go for 75¢ and above, with only 40 per cent retailing at 35¢.

"Stores carrying \$10,000 record stocks, as in the old days, are exceptions now," say Mr. Hassmer. "A \$150 to \$175 layout is common. There are five groups of buyers:

1. Women who prefer highbrow records.
2. People born in other lands who like foreign tunes.
3. Second generation foreigners, and certain American groups who like the movie performers, such as Nelson Eddy and Jeannette MacDonald.
4. Kids and college students who like swing stuff and follow popular bands.
5. Men who are the big symphonic buyers.

"To sell records, a store must have floor traffic. Any firm that has people coming in to make payments on merchandise or electric and gas bills, is in an ideal spot for record business."

Prices of radio combinations are down, dealers need a handle for trading up sales, repeat business is profitable and has little sales cost, and finally certain segments of the public likes the idea of what it wants when it wants it—there are the forces which are swinging the trend to dinner music at 8—served as you want it.

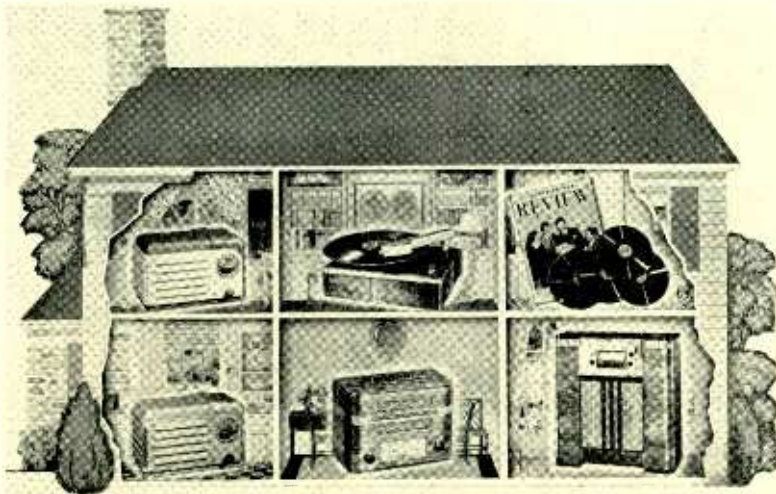

BIG SIX—Graphically illustrated is the “package” offered this month by RCA Victor for \$159.90 FOB Camden. Included is a 7-tube console grand electric tuning radio, three table models, a Victrola attachment, a choice of \$9 worth of records and membership in the Victor Record Society

RCA Victor Drive On

“Big Six” package offer, oldest Victrola search high spots of 40th anniversary campaign

CAMDEN—Swinging into an intense merchandising drive in celebration of its 40th anniversary is RCA Victor. High-spots of the drive are a “Big Six” package offer and a search to find the oldest Victrolas in existence. Many other promotions are simultaneously planned.

Included in the Big Six offer is a 7-tube console grand radio, three table models, a Victrola attachment and a personal selection of \$9 worth of Victor or Bluebird records with membership in the Victor Record Society. The lot sells for \$159.90 FOB Camden. This, thinks advertising manager Tom Joyce, is one effective method of bringing to the attention of the consumer the need for several radios per home, a means of playing records. “More sets per home,” states Mr. Joyce, “is at once a logical convenience for the consumer and a business-building effort for the radio dealer in whose interests the Big Six plan was devised.”

The firm’s effort to discover the oldest Victrola will be nationwide, carries with it an offer of \$250 in cash for oldest machines manufactured in each of the years between 1906 and 1925. Dealers forwarding winning entries will also be rewarded, with \$250 worth of RCA Victor merchandise. The search started October 15, closes December 1.

Prizes for Plastics

Zenith, Detrola, Emerson offerings click with judges

NEW YORK—Winner of the first award in the household group of the Third Annual Modern Plastics Competition, sponsored by Modern Plastics magazine, was Zenith, with its “Radio Nurse.” Detrola’s “Pee-Wee” radio cabinet clicked, brought off second award in the

decorative group. Contrasting colors in Emerson’s college model radios won honorable mention in the decorative group.

QEAMA Breaks Into Print

Queens dealers launch house organ, honor hard-hitting J. E. Hardee

JAMAICA, N. Y.—Into print with the first issue of the QEAMA Monthly News broke the Electric Appliance Merchant’s Association of Queens, Incorporated, October 25. Edited by James Liebman and Paul Jappe, the bulletin will go to the organization’s 75 members monthly, containing an editorial by president Sam Stein, many other features by officers and members.

Dedicated to J. E. Hardee, last sea-

son’s president and now on the Association’s advisory board, was the October 25 meeting held at the Diplomat Restaurant. Hardee received a bronze plaque praising his leadership in Association affairs; the plaudits of present officers; J. J. Schmeer and Tom Bolger of the Electrical Appliance Dealer’s Association of Brooklyn; other prominent guests.

Headlined speaker of the evening was Jim Michael, eastern division manager of the Apex Rotarex Corporation, who told assembled dealers of their opportunity to cash in on “Washer Week.” Other men at the speaker’s table discussed the local Utility’s current “package plan,” producing sales in excess of expectations; new methods of putting “teeth” in the local Feld-Crawford fair trade act upon which the League of Metropolitan Dealers (of which QEAMA is a member) is concentrating.

Guiding QEAMA affairs for the year under the guidance of president Stein are newly elected officers including Paul Jappe, C. Schimpf, Wallace H. Palmer, Harold Birns, Herman Schwartz and Ned Rose.

Stromberg-Carlson Ups Prices

ROCHESTER—Increased prices, f.o.b. this city on three Stromberg-Carlson Labyrinth radios to go into effect November 25 or earlier, have been announced by radio sales manager Lee McCaune. No. 340-M will list at \$135 instead of \$127.50; No. 345-M at \$159.50 instead of \$150; No. 350-M at \$187.50 instead of \$175.

Said McCaune: “These three models were deliberately priced low when introduced in order to more quickly acquaint the public with the advantages of the Labyrinth. Now, with the Labyrinth story so well known, and so many orders received, it seems advisable to advance prices to cover their true worth.”



DEMONSTRATE TO SELL—Urging the trade to demonstrate its pioneering wireless type record player to everyone who enters the store is the Wilcox-Gay Corporation, now conducting a drive on the products. “Fact that any set in the store can be used for reproduction merely by tuning it to the proper frequency makes demonstration simple,” says president Chester M. Wilcox



Smart Merchandisers will promote

RCA Victrolas

Christmas has always been the traditional peak season for musical merchandise. But this Christmas will be a record-breaker for merchants handling RCA VICTROLAS and VICTOR and BLUEBIRD RECORDS—for never before in its forty-year history has RCA VICTOR been able to offer so many "scoops"—merchandise and merchandising ideas which have not been available at any other Christmas season. It's a profit opportunity you can't afford to miss!

Scoop

\$40.00 TRADE-IN OFFER — Never before a Christmas value like this! Not only is the Fortieth Anniversary RCA Victrola Model U-125 a superb instrument in every way — but it is the greatest musical merchandising "scoop" in forty years. For with this instrument you can offer your customers a \$40 trade-in on any radio or phonograph regardless of age or make, thus enabling them to get this \$175* value for only \$135*. And, in addition, they get \$9 worth of their choice of Victor or Bluebird Records, a \$2 year's subscription to the Victor Record Review and membership in the Victor Record Society — all at no extra cost! What a volume item U-125 will be this Christmas.



Scoop

\$5,000.00 CONTEST. Never before have you been able to offer such an effective, intriguing sales-making contest as the Oldest Victrola Contest! It carries a \$250 first prize for the oldest Victrola in each year from 1906 through 1925. If a winner registers at your store, you receive a \$250 prize in merchandise. Contestants *must* make application through you.

*Prices f.o.b. Camden, N. J., subject to change without notice



Scoop

RECORD BONUS — Never before have you been able to offer on practically every RCA Victrola sale either \$9.00 worth or \$4.50 worth (depending on price of set) of Victor or Bluebird Records. In addition, your customer gets a \$2.00 year's subscription to the Victor Record Review and membership in the Victor Record Society.

these Money-Making "Scoops" on —

for Christmas Profits

Scoop

VICTOR RECORD SOCIETY CHRISTMAS PACKAGE.

Never before have you been able to offer the Victor Record Society Christmas package, done in sparkling color reflecting the Christmas atmosphere. Boxes available separately for R-93B's now in your stock. Victor Record Society package is an ideal, inexpensive gift that will keep on giving you profits the whole year round. It's a \$25.95 value which includes the RCA Victrola Attachment, \$9 worth of Victor or Bluebird Records, a \$2 year's subscription to the Victor Record Review and membership in the Victor Record Society — all for the amazingly low price of \$14.95. Thousands will be given as gifts this Christmas.

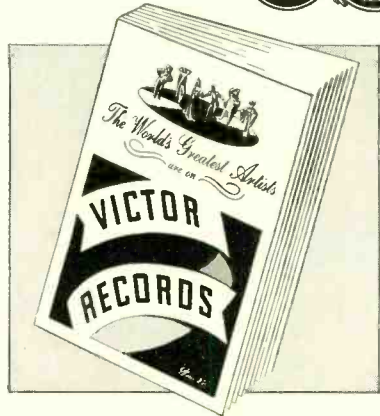

Scoop

VICTROLA BUTTON. Never before have you had such an *extra sales* feature as the Victrola Button—which is on every RCA Victor 1939 model of two bands and six tubes or more. When demonstrating an RCA Victor Radio with Victrola Button it's easy to "plus" the sale with a \$14.95 Victor Record Society membership.



Scoop

VICTOR RECORD CATALOG. Never before has the Victor Record Catalog been so complete an index of Christmas gifts! The greatest gift catalog in the world, it will pay you to keep plenty of these available on your counters and in your listening booths. Listing approximately 6500 Victor Record selections it will satisfy any gift want in music.

Scoop

CHRISTMAS RECORD PACKAGE. Never before have you been able to offer this appealing Victor Record Christmas package! Bright and gay with color, a package alive with Christmas spirit, it's the ideal gift for members of the family, friends or relatives. Christmas Boxes available in different sizes for Victor Records and albums.



More Scoops!

Scoop

Never before have you been able to offer so complete a line of low cost Victrolas!

A splendid gift for college students! Model U-112 (upper left) is a real triumph of Victrola value. Has Feather-touch Crystal Pick-up and True-Tracking Tone Arm. Radio has automatic volume control, RCA Victor Metal Tubes and many other features. Price only . . . **\$39.95***

An ideal gift for young people! Victrola Model U-104 (lower left) is the lowest priced RCA Victrola combination in history! Features Feather-touch Crystal Pick-up, True-Tracking Tone Arm, Tone Control for **\$19.95*** radio and phonograph!

Just the gift for the family's swing fan! Model R-91 (lower right),

phonograph only) plays 10" and 12" records with lid closed, has Feather-touch Crystal Pick-up, True-Tracking Tone Arm, cushion mounted, constant speed motor, tilting Tone Arm for easy insertion of needles, and other fine features, yet costs **\$32.95*** only

What a grand gift for the record enthusiast! Model U-115 (upper right). Amazing advanced features... a real quality instrument priced within reach of all. Feather-touch Crystal Pick-up, True-Tracking Tone Arm and Automatic Stop. Radio with RCA Victor Improved Electric Tuning and many other ultra-modern features. Only **\$59.95***

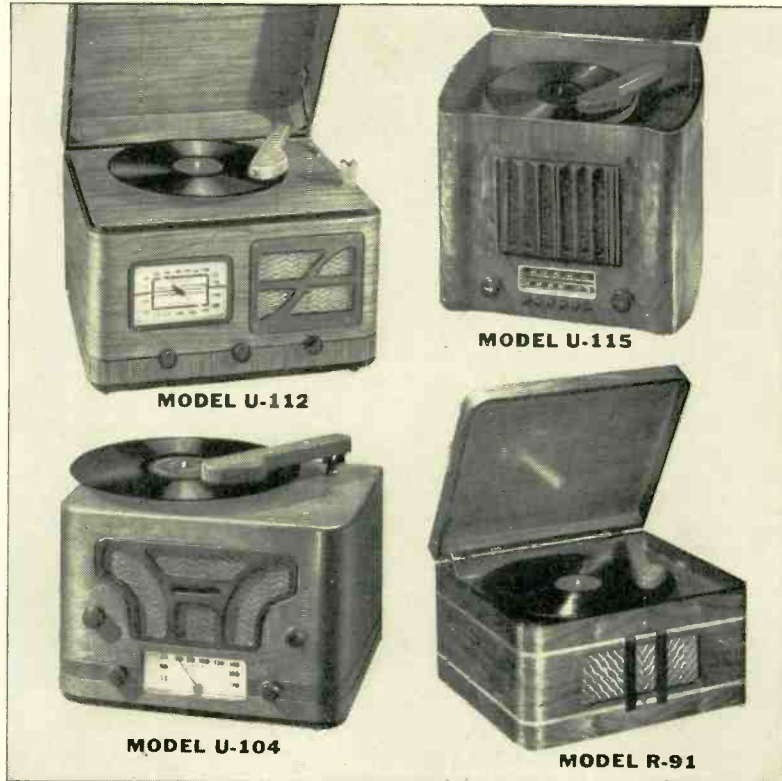

MODEL U-112

MODEL U-115

MODEL U-104

MODEL R-91



Scoop

Never before have you been able to offer distinguished customers so splendid an instrument as the RCA Victrola U-134A with its beautiful 18th Century cabinet (at left). It combines Victor Record and radio entertainment, has new Gentle Action Automatic Record Changer, Feather-touch Crystal Pick-up with top loading needle socket. 16-tube radio has Electric Tuning for 8 stations. In walnut, \$355*—in mahogany, \$365*.

*Prices f. o. b. Camden, N. J., subject to change without notice.



RCA Victrolas

A SERVICE OF THE RADIO CORPORATION OF AMERICA

Advertising Scoops!

Sales-Making Advertising

*Sales-clinching merchandise
have started a landslide to*

RCA VICTROLAS
and

VICTOR and BLUEBIRD RECORDS

As each month drops off the calendar, the swing to RCA Victrolas and Victor Records grows greater. All across the country, more and more prospective customers become *actual* customers. And if you don't think there is a tremendous swing to RCA Victrolas and Victor Records, then look at the way national magazines and leading newspapers have recognized it! These publications, reaching millions and millions, carry "Record Reviews" as a steady feature. What powerful *extra* publicity for you to cash in on!

Who started it all? RCA Victor! And RCA Victor has pushed it for-

ward with an unbeatable combination of fine merchandise and fine advertising.

"The Magic Key of RCA" program...nightly Victor Record programs...national magazine and newspaper advertising...powerful sales promotion material...all have told millions from coast to coast the sensational story of the new RCA Victrolas and Victor Records...have sold them the joy of having "the music you want when you want it." Take advantage of the splendid profit opportunity RCA Victor offers—and your sales and profits will reach new peaks.

FLASH! Davega—purchaser of 300 Models U-125 when these instruments were originally introduced—has just ordered 300 more—a total of 600 in all. They plan to sell 2,000 by Christmas.

*Listen to the Magic Key every Sunday, 2 to 3 P.M., E.S.T., over NBC Blue Network
For finer radio performance—RCA Victor Radio Tubes*



VICTOR RECORDS

BLUEBIRD RECORDS

RCA MANUFACTURING CO., INC., CAMDEN, NEW JERSEY

Another City Fights Noise

NAPRI group sponsors West Coast ordinance

SAN FRANCISCO—An ordinance to regulate the use of electrical devices, appliances, equipment which interferes with reception of radio signals has been introduced here. Sponsor is the Golden Gate Chapter of the International DX'ers Alliance, affiliated with the National Association for the Prevention of Radio Interference.

Highspots of the ordinance provide:

(a) That owners or users of offending equipment be notified to abate the nuisance in 5 days, (b) City officials recommend definite remedial steps on the premises if offenders do not take action, (c) City officials be empowered to cause shutdown in power supplied premises causing interference in the event interference is serious, as with fire or police broadcasting services, (d) A Maximum of \$250 fine, or 6 months in jail, or both, may be imposed for continuous violation.

Radio stations licensed by the government, public utilities and city services are exempt from these provisions, would be otherwise aided to minimize possible interference.

Washer Week Clicks

Industry drive brings top sales figures for all time

CHICAGO—From the office of Joseph R. Bohnen, executive secretary of the American Washer and Ironer Manufacturer's Association, comes word that "Washer and Ironer Week" campaigning, October 23-29, brought sales totals to the highest point ever achieved by the industry in a similar period.

More than a million extra lines of national advertising was placed by co-operating utilities and dealers. Promotional material stock was exhausted 10 days before the drive started. It is estimated that retail washer and ironer sales totalled 60,000. Climaxing the industry's six-day drive was the Association announcement that September factory shipments totalled 125,821, close to the August eleven-month high of 129,163, and only 15.69 per cent below September, 1937.

New Westinghouse V.P.

MANSFIELD, OHIO—Frank B. Williams, Jr., formerly of the Diehl Manufacturing Company, has been elected vice-president in charge of the merchandising division of the Westinghouse Electric & Manufacturing Company, with headquarters here. He succeeds A. E. Allen, resigned.

Electric Lamp Ups Hansen

ST. LOUIS—W. I. Hansen, for some time general manager of the Electric Lamp & Supply Company, prominent radio-appliance distributor, has been elevated to the position of vice-president.



ABLE TEACHER—*Thomas F. Joyce*, advertising and sales promotion manager of the RCA Manufacturing Company, Inc., spoke on "The Sales and Advertising Plan" before 500 students of the advertising and selling course of the Advertising Club of New York November 7. His talk, augmented by demonstrations and slides, treated with the RCA promotional program back of the revival of records, radio-phonograph combinations and record-players

Two Norgemen Upped

DETROIT—M. G. O'Harry of Borg-Warner's Norge division has been advanced from the position of eastern sales manager to that of vice-president in charge of sales. P. B. Zimmerman has been advanced from his former position as vice-president in charge of Norge Division sales to that of vice-president and assistant to the president.

Second For Terminal

NEW YORK—On December 1, Terminal Radio Corporation of 80 Cortlandt Street opens another store. Located uptown at 68 West 45th Street, the new store will carry a complete stock, including radio parts, communication receivers, sound equipment.



NEAR AND YET FAR—On *John Erwood's* office wall out at Webster-Chicago is a photo of a sub-chaser. He served on a sistership during the war, ferrying between the States and a point 50 miles off the French coast. Out of electrical experience in the Navy grew his present firm's sound business. The payoff . . . John never did get to see Paris!

JOBBERs and REPRESENTATIVES in the News

HOWARD—Southern Alabama distribution goes to the McGowan-Lyons Hardware Company of Mobile, one of the oldest hardware jobbers in the state. Howard representative E. L. Hollingsworth, of Hollingsworth and Still, will assist the firm in presenting new sets to dealers.

HOWARD—*J. M. Cartwright* will represent this company in Arkansas, Mississippi, Louisiana and western Tennessee, out of offices at 1288 Vinton, Memphis.

STROMBERG-CARLSON—So far reaching was the success of Stromberg-Carlson's "Labyrinth Proving Display" that the company now announces a similar device to demonstrate the superiority of Carpinchoe leather speakers. Two speakers are arranged on a display board so that the customer can feel the difference in pliability which permits better tone rendition.

STROMBERG - CARLSON—Union Supply Company of Burlington, Iowa, appliance distributor, has been given this company's franchise to distribute S-C sets and parts in its territory.

STROMBERG-CARLSON—*John Hoyt* has just been appointed sales representative in the northwest, will make his headquarters either in Seattle or Spokane.

STROMBERG-CARLSON—*Tennessee Valley Appliances, Inc.* of 305 11th Ave., S., Nashville, now has the line in Tennessee east of the Tennessee river, also distributes Norge products.

STROMBERG-CARLSON—Sales rep *Ted Holzem* of Milwaukee has had his territory increased to include central Illinois, eastern Iowa, greater Wisconsin and most of the northern Michigan peninsula. New distributors: *Specialty Distributing* of Detroit, for local area and throughout eastern Michigan; *Radio Studios* of Salt Lake, parts of Nevada and Idaho and the entire state of Utah. Maintains branches in Ogden and Logan, Utah.

EMERSON—*Hopkins Equipment Company* now has Emerson as exclusive distributor in Atlanta. W. D. V. Hopkins heads up the firm.

BENDIX—Home laundry distribution for Nebraska and western Iowa goes to the *Radio Accessories Company* of Omaha, already pushing Motorola radios, ABC washers and ironers, Permutit water softeners. Lowell J. Grafft, new salesman, will do special Bendix promotion.

PHILCO—*T. W. William* has been transferred from Des Moines to Milwaukee as district rep, will cover Iowa and Wisconsin.



OUT FOR RECORDS—"Coach" *Ted Wallerstein*, RCA Victor's record sales manager, gives his Bluebird sales team a pep talk preceding a concentrated drive

Brooklyn Dealers Meet

Cite Feld-Crawford violations, get figures on Utility "package plan" sales

BROOKLYN—Much has been accomplished by the Electrical Appliance Dealers Association of Brooklyn toward stabilization of retail radio prices, stated chairman of the radio committee Percy Peters, speaking before the group here October 26. Violation of Feld-Crawford act provisions in a few isolated cases was admitted but it was pointed out that a proposed new plan of cooperation would put additional "teeth" in the measure locally.

Announced during the meeting by a representative of the Brooklyn Edison Company were "package plan" sales totals to date. Brooklyn sold 44,274; Manhattan 24,528; Bronx 12,879; Queens 22,475 and Westchester 9,393, with the campaign still running.

Featured speakers included Tom W. Bolger, the Associations' new executive secretary; Hal Sheer of Philco; Jules M. Smith of Davega and Max Kassover of Vim.

Univex in New Quarters

NEW YORK—New and larger offices are now being occupied by the Universal Camera Corporation at 28-30 West 23rd Street. Included are executive, sales, engineering and general offices, service department, factory and a reception lobby in which a complete display of available merchandise is maintained. Visitors are invited.

Kelvinator Hires Stuart, Parsons

DETROIT—J. Nelson Stuart, until recently advertising and sales promotion manager for The D, L and W Coal Company, has been appointed director of advertising and sales promotion of the Nash-Kelvinator Corporation's Kelvinator Division, with headquarters here.

Harry Parsons, formerly of the Walker & Pratt Manufacturing Company, has been appointed sales manager of the Kelvinator range and water heater section.



FACTS ABOUT RECORD PLAYERS



DE LUXE MODEL A-60



STANDARD MODEL A-56

1. The Wilcox-Gay record player is the best way for most families to enjoy phonograph music—used with a console radio it gives better performance than any but very highest quality phonograph combinations and at less cost than any other method.
2. Its wireless feature is not a novelty but the only practical solution of the problem of record-playing through your radio.
3. The Wilcox-Gay wireless record player was announced June 1st, and thousands of profitable retail sales were made by Wilcox-Gay dealers during July, August and September, months in which these dealers might otherwise have run in the red.
4. The sensational success of the Wilcox-Gay Wireless record player has inspired numerous imitations. We are complimented, of course. Perhaps these imitations are good. We want you to remember, however, that the Wilcox-Gay player is known to be good by tens of thousands of successful sales, that Wilcox-Gay offers you a \$19.95 retail price and a generous discount and that Wilcox-Gay uncovered this gold mine of extra business for the radio industry.

and now Wilcox-Gay gives you the

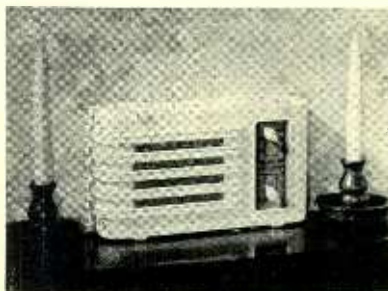

MODEL A-53

THIN MAN

Five tube superheterodyne—a new design in radio with plenty of "umph" in performance and eye appeal. Lay it on the table or hang it on the wall—any side but one is up, adaptable to any location. A beautiful plastic model available in four colors.

Here are six special features by Wilcox-Gay you should investigate regardless of what your present radio line may be.

- 1 THE ORIGINAL WIRELESS RECORD PLAYER.
- 2 THE VERSATILE "THIN MAN" RADIO.
- 3 AN ALL WALNUT SENSATIONAL CONSOLE AT \$59.95.
- 4 THE CONVERTIBLE WAL-CHAIRSIDE MODEL.
- 5 AN UNUSUAL PUSH-PULL TABLE SET AT \$36.95.
- 6 NEW PERFORMANCE IN A COMPACT BATTERY JOB.

Send me your new catalog which shows how Wilcox-Gay can make my radio business more profitable.

Name _____

Address _____

WILCOX-GAY CORPORATION

CHARLOTTE

MICHIGAN

U. S. A.

Northwesterners Protest Cheap Sets

NRRAA sends strong letter to manufacturers, says \$5 to \$15 is too low.

MINNEAPOLIS—To leading radio receiver manufacturers October 14 from the influential Northwest Radio, Refrigeration and Appliance Association went a strongly worded letter of protest against inclusion in popular lines of sets listing between \$5 and \$15. Such lists, according to newly elected officers including president H. A. MacDowell vice-presidents L. R. Watson and A. J. Newman,

secretary A. L. Toepel, treasurer P. J. Brady and executive secretary H. H. Cory, are detrimental to jobbers and dealers and, in the end, to manufacturers. Members of the Association and other retailers throughout the Northwest will be urged to register individual protests.

Reads the letter:

"Our Association wishes to protest to the leading radio manufacturers against the making of the \$5.00 to \$15.00 receiving sets. At our October meeting this week a long discussion brought out the following objections to these sets:

Neither the retailer or jobber make enough when one is sold to pay for any advertising or selling effort.

Having to display these low priced sets cheapens the name of any well known line of sets.

Instead of being used as extra sets in the home, 30% to 40% of them become the only set in the home.

They are positively detrimental to our publicity campaign to try to get the public to listen to long distance programs and foreign reception.

Radio service shops and departments are bitter against them as customers don't want to pay but a few cents to have them repaired when it is necessary.

Broadcasters and sponsors object because of the poor reception and clarity on the tiny sets.

The retailer often loses an old and steady customer for his other merchandise because of arguments that develop over the servicing and guarantee on cheap sets.

Service shops and retailers turn against and knock the set manufacturers that enclose any coupon or notice offering to repair the sets for a small price if mailed back to the factory. This makes it very hard for the jobber to hold his dealers or get new ones.

Independent dealers and jobbers are perfectly willing for the mail order houses, chain stores and drug stores to have the cheap set business as it is a losing proposition. Somebody will always be the cheapest and they will take care of cutting each others throats.

Independent dealers and jobbers have an established clientele from which they can always get a fair volume of business and they can make money providing the manufacturer makes good merchandise and prices it high enough to yield a fair profit.

If the dollar volume and the total profit in dollars is lowered any farther, many firms will drop any special selling efforts or discontinue their departments altogether.

Dealers and jobbers are only concerned about the ten or twelve leading lines of nationally advertised sets. They would not sell the unlicensed sets of attic and cellar racketeers anyway no matter if the price went to a \$1.95.

Dealers say it is nothing but an alibi for the manufacturer's or jobber's salesmen to say they have to come out with these low priced sets to meet competition or because somebody else did it.

"Remembering the scores of failures of radio set manufacturers in the past fifteen years, dealers are always suspicious that any manufacturer who constantly reduces prices is shaky and hard pressed to raise cash, whether that is true or not.

"Dealers feel that it is far better policy for the manufacturer to make good, strong, beautiful and efficient sets on which he can make a good profit and have money to spend for advertising and sales promotion than to see how cheap he can make a set.

"Will you join us in our campaign against the cheap no-profit-to-anyone set? We intend to carry our story to dealers or jobbers who are thus dragging down and ruining the whole industry."

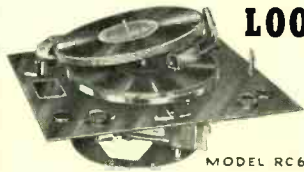

LOOKING FOR CLUES?

"Garrard" is the clue to increased sales for YOU. You can have "Garrard" Automatic Record Changers built into the phono-radios you carry (leading manufacturer

ers use them on request) or feature "Garrard" units for custom assemblies and modernization jobs. Cash in on the demand for quality record playing equipment. Push "Garrard" for the answer to your sales "mystery."

GARRARD SALES CORP., 17 WARREN STREET, N. Y.

SEND TODAY FOR CATALOG No. 57-L

GARRARD

Automatic Record Changers

Records Becoming More and More Important! RECOTON Helps Dealers in Many Ways

This organization is devoted to the development of accessories that further the profitable merchandising of RECORDS. Our strictly QUALITY products will help your Record Department, whether new or long-established. Get acquainted!

NEW RECORD RENEWER

A double-purpose fluid which not only CLEANSSES but LUBRICATES as well. Penetrates into the grooves, removing dust and grit, etc. Leaves a thin film that makes things easy for the needle, reducing surface noise and preserving original fidelity of the recording.

Steel and Sapphire

RECORDING NEEDLES

If you have a new Recording Section, let RECOTON peerless recording needles help you to profits and good will. To serve best your interest in economy, or quality, or BOTH, these are the recording needles for YOU!

ALSO Push our Superior Playback Needles (10 perfect plays to each needle) and RECOTON Acoustic Needle for a better BASE rendering.

RECOTON

Corporation, 178 Prince St., New York City



The Height of Convenience!

PORTABLE PHONO-ATTACHMENT

Here is a high-fidelity reproducer in smallest size! An ingenious little walnut cabinet equipped with a high-grade crystal pick-up, which fits under or over the radio! Just pull a drawer and you're ready! AC or DC; 12" turntable.

Write for complete literature on all RECOTON products.

Mackie Still Laid Up

DETROIT—From Jim Davis of Detrola comes word that Earl Mackie, who suffered a broken leg and ankle in a motor crash September 8, is recuperating slowly but satisfactorily in a plaster cast at St. Joseph's Hospital, Lorraine, Ohio. According to Jim, Earl will probably remain in the hospital until just before Christmas.

New Leonard Adman

DETROIT—J. Truman Steinko has been appointed advertising and sales promotion manager for Nash-Kelvinator's Leonard Division. He has been with the corporation since 1934.

New Meissner Service

MT. CARMEL, ILL.—The Meissner Manufacturing Company of this city has inaugurated a new coil repair and re-winding service. Object, according to the management, is to eliminate handling of a large stock of slow-moving "exact duplicate" replacement coils on the part of the jobber as well as the coil manufacturer. Prompt and efficient service is guaranteed under this new policy and a flat rate of \$1 is to be made wherever possible.

Mr. Radio Dealer!

Your phonograph-radio customers will welcome relief from bothersome needle changing. Supply their needs with only proven (10 years) long play needles! More than 1000 high fidelity reproductions with each Permo 'Round' Point Needle!

PERMO Round POINT PHONOGRAPH NEEDLES

2 for \$1 Retail Price
2000 PERFECT PLAYS



Needle card can be used for checking turntable speed . . . a necessity for quality reproduction and satisfied customers.

ASK YOUR RECORD DISTRIBUTOR OR WRITE US DIRECT

PERMO PRODUCTS Corporation

Manufacturing Metallurgists

6415 RAVENSWOOD AVE. CHICAGO, ILL.

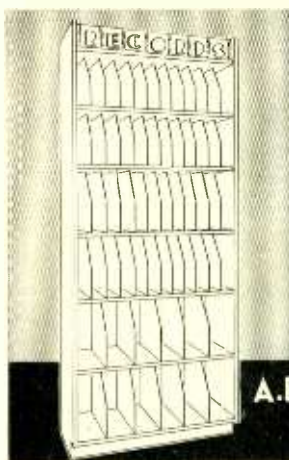

TAKING ON RECORDS?

More radio and music dealers are selling phonograph records and expanding record departments.

Adequate attractive display, storage, demonstration booth, and counter equipment is important to sales.

Standard and special equipment available in different wood finishes. Prices extremely reasonable.

We invite your correspondence.

A. BITTER CONSTRUCTION Co.
27-01 BRIDGE PLAZA N^o.
LONG ISLAND CITY N.Y.

110 VOLTS AC ANYWHERE!

With KATOLIGHT. Furnish standard 60-cycle AC for operating sound truck equipment, AC radios, transmitters, flood lights, motors, moving picture projectors, etc.



A complete line of light and power plants ranging up to 10,000 watts capacity. Also 6, 12 and 32 volt battery charging plants, Diesel plants, rotary converters, and frequency chargers.

List prices \$50.00 and up.
Kato Engineering Company
MANKATO, MINN., U.S.A.

Pick NEW Constant Speed

Flyer CX Phonograph Motors

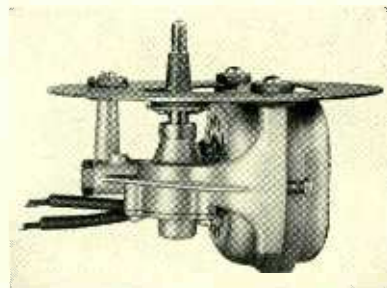

GET acquainted with the new constant speed Flyer CX Phonograph



New Model CX. 8", 9", 10", 12" turntable included.

Motor. Latest General Industries development after many years of leadership and production of millions of phonograph motors. Buy it for your installations. Specify it in portable and table models. Sell it "as is" . . . Constant speed developed to highest perfection in a light motor. Especially suited to small instruments. Self-starting. Quick in reaching running speed. Fan cooled—free ventilation and cool operation. Silent helical-cut gears and large bearings, in sealed chamber with ample oil reserve. Turntable (not shown) has patented drive, giving positive insulation between turntable and motor. Order a Model CX Flyer Motor for testing—and specify frequency and voltage of current you use. Write for Catalog Sheet and Prices.

. . . and Pick POPULAR Record Changers



Model "M"
Choice Range

GET in and share generously in the profits from supplying popular-priced radio-phonographs and phonographs equipped for automatic record changing. Pick the practical, remarkably low priced General Industries record changer units for your own installations. Specify them in sets to handle. They come ready assembled, and easily installed—including Flyer induction type self-starting motor, high fidelity crystal or magnetic pickup, and simple, efficient, foolproof changer mechanism, all on mounting board.

In ordering sample motors or changer units for testing, be sure to specify exact voltage and frequency of current you use.

The GENERAL INDUSTRIES CO.

3837 Taylor Street

Elyria, Ohio

this year send TALKING Christmas Cards



Here is a new idea featured in Presto advertising in these national magazines and in leading trade papers.



Over 400 Presto dealers are now profiting from this Christmas promotion. Thousands of prospects are being directed to their stores to record their Christmas greetings to friends and relatives and to buy other merchandise as well.

You too can get the benefit of this advertising. Become a Presto dealer. Equip yourself to make personal recordings for your customers. Order the equipment listed below.



One Presto type 6-J recorder	\$162.50
Ten 10" Orange Seal discs	8.00
One sapphire cutting needle	6.00
One package steel playing needles	.80
One 2 oz. can disclube	.45
Window display and literature	N/C

TOTAL \$177.75
Less regular dealer discount

ACT PROMPTLY. GET THE VALUABLE PRESTO FRANCHISE FOR YOUR CITY. SEND IN YOUR ORDER TODAY.

PRESTO RECORDING CORP.
135 W. 19 St., N. Y. C.



WEST COAST KINGPINS—The staff of Woods Radio & Electric, on the Pacific Coast welcome new widely diversified Emerson line, for which they have just obtained a retail franchise. Second from left: Charles Weiser, Emerson's Pacific Coast rep. Second from right: A. M. Witte, district rep for the F. B. Connolly Company, distributor

Bit for Charity

NEW YORK—Co-chairmen of the Radio and Musical Instruments Division of the New York and Brooklyn Federations of Jewish Charities are Max and Samuel Kassover of Vim Radio, Jules M. Smith and Herman M. Stein of Davega-City Radio. Henry Benjamin of Davega-City Radio is honorary chairman.

Stewart-Warner Sells Hudson

CHICAGO—New Hudson motor cars will use auto radios made exclusively for them by the Stewart-Warner Corporation. Included are six and seven tube models to be obtainable as stock equipment or through Hudson dealers. Both sets are "unitized", have speakers and chassis in the one case.



BUYS FERGUSON—Joe Gerl, president of Chicago's Sonora Radio and Television Corporation, whose firm has just purchased the Ferguson Radio and Television Corporation of New York. Plans are under way to coordinate and expand both companies

American Comm Expands

NEW YORK—The American Communications Corporation, of which E. M. Lurie is president, has increased its manufacturing facilities by leasing extensive factory and office space at 123 Liberty Street. ACC makes code readers, oscillators, burglar alarms and centralized radio systems.

NEW CHIME RECORDS

Electrical transcriptions of the famous Rangertone Chimes.

Make additional profits by the sale of this excellent Christmas item.

For homes, churches, institutions, etc.

12 inch durable recordings (not acetate)

Excellent tonality—very low surface—will also promote your amplifier sales.

Two sides—five minutes each—(78 R.P.M.)

RECORD NO. 528

Oh, Little Town of Bethlehem
The First Noel . . . We Three Kings
Oh! Come All Ye Faithful

RECORD NO. 529

Hark! The Herald Angels Sing
It Came Upon A Midnight Clear
Oh, Holy Night

List price \$4.00 each . . . prompt deliveries. Order your supply at once.

RANGERTONE, INC.
ELECTRIC-MUSIC

201 Vernona Ave., Newark, New Jersey

CONSOLES *Go Places!*



EMERSON—Combination, Model BR224, 13 tube a.c. superhet.



PHILCO—Model 36XX, 6 tube, eight station, push button tuning.



STROMBERG-CARLSON—Model 340-W, 8 station push button tuning. Walnut.



MAGNAVOX—Radio phono combination, 540-18000 kc.

THE '39 consoles offer new and attractive lures with which to bait a successful sales story and clinch sales. Backed up by demonstrably high-class radio reception, new consoles offer an interesting variety of "reasons to buy" which are sure to appeal to a wide variety of personal preferences. In our showing this month, there is a generous sprinkling of the increasingly popular phonograph combinations. Sets which have appeal as pieces of furniture compliment the well-groomed lines of standard consoles.

No longer are console sizes uniform. Proportions are so varied that size and shape may be chosen to fit the spot in the home which the new set is to fill. For the narrow wall space there is the taller set, with perhaps a concealed drawer to hold the record album, which one manufacturer offers in a combination set. A corner cabinet in walnut solves the problem of the corner ensemble that needs a radio to complete it. Bookshelves add to the interest of another console, and a spinet type and 18th Century designs in cabinets will catch the eye of the most casual "looker". In general the broad sleek lines and hand rubbed finish of fine woods give a sense of well-being and luxury to any home to which the '39 sets may go.

It looks like a good year for consoles, they are really going places—the more because they are groomed and ready to add to any setting—as furniture—as radio. There are sales waiting for the dealer. Sales behind which there is an attractive profit margin. *One sale, one demonstration, one delivery, one transaction, and the cash register has closed on a profitable sale.*



GENERAL ELECTRIC—Model G-75, 7 tubes, 2 bands, touch tuning.



DETROLA—Model 258EPC, 8 tube combination.



R C A—Combination Fortieth Anniversary model 8 tube a.c.



ARVIN—Model 1247D, 12 tube, push button and dial tuning.



ANSLEY—Whitby with or without automatic record changer.

New TABLE MODELS

WILCOX-GAY

Wilcox-Gay Corporation
Charlotte, Mich.

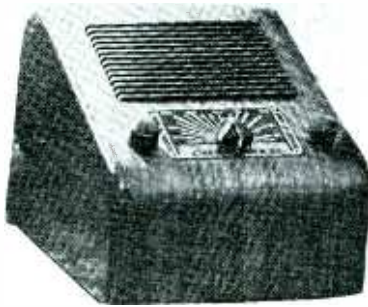

The unique design of this superhet a.c.-d.c. five tube portable table set houses a chassis which offers continuously variable tone control, dynamic speaker, sloping panel and surface vision dial. Finished on all sides to fit on desk, bedside or chairside table.

For hanging on the wall or with a chairside stand this thin, streamlined case contains a five tube a.c. superhet chassis covering broadcast and upper police bands. Automatic volume control, tone control, slide rule dial.



CROSLLEY

Crosley Corp.
Cincinnati, Ohio



Features push button tuning, equipped with a beam output power tube which provides greater volume and sensitivity. Encased in a cabinet of old ivory Plaskon, this de luxe model is so compact that it may be used for a book end.

R C A

R C A Manufacturing Co.
Camden, N. J.



COMBINATION — Three new low-cost table models complete R C A Victrola line with prices ranging from \$19.95 to \$355.00. They are model U-104 at \$19.95, model U-115 at \$59.95, Model U-112 at \$39.95. Housed in attractive cabinets, the new models incorporate latest developments. U-112 illustrated.

STEWART-WARNER

Stewart-Warner Corporation
1826 Diversey Parkway, Chicago, Ill.



COMBINATION — Radio-phonograph plays 10 and 12 in. records, has self-starting motor and crystal pick-up. Superhet, five station Magic Keyboard Tuning, 6-in. dynamic speaker, 6 tubes, automatic volume control.

FADA

Fada Radio and Electric Co.
30-20 Thompson Ave., Long Island City, N. Y.

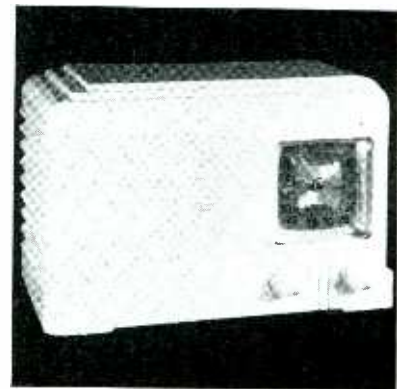

MODEL 5F50 Series in walnut or ivory plastic covers a tuning range from 545 to 1650 kc. Illuminated dial; automatic overload control; beam power output; power line noise filter, output stage power two watts; high gain antenna and r.f. transformers. Reduction drive tuning.

SONORA

Sonora Electric Phonograph Co., Inc.
132 W. 22nd St., New York, N. Y.



RECORD PLAYER—Model PBW "Mystic Music Maker" plugs into house socket with no wired connection to radio. Self-starting motor, automatic stop, crystal pickup, volume control with switch. Plays 10 and 12 in. records. Walnut cabinet.

DEWALD

Pierce-Airo, Inc.
430 Lafayette St., New York



BANTAM—A four tube bantam set housed in a plastic cabinet in a variety of colors. Beam power output, p.m. dynamic speaker, general broadcast and state police band.



BUILDS A FUTURE

for the

RADIO SERVICE DEALERS OF AMERICA

The modern radio tube is the heart of all electronic apparatus. Every present form of radio receiver and transmitter, sound re-enforcement and motion picture sound equipment, as well as a great many other electrical mechanisms, depend entirely upon the radio tube for proper operation.

The development and growth of the radio art and industry has, in a large measure, been dependent upon the ability of radio engineers to design radio tubes that will properly perform very definite functions.

Since the beginning of radio, RCA has spent millions of dollars in radio tube research, and in addition has concentrated its tremendous facilities upon the problem of developing and manufacturing radio tubes which must meet exacting specifications. As a result of this continued activity RCA Radio Tubes have rightfully earned a reputation for reliability and uniformity of quality which has long been the envy of the radio industry.

At some time in the future, a new electronic marvel may be serving the public—TELEVISION. Here, too, RCA has played an historic role by pioneering a potentially great art and industry. It was the knowledge of these fundamental electronic principles of the radio tube which has brought Television to its present stage of practical development.

As more radio and electronic devices come out of the laboratory and into general use, more opportunities are provided for the aggressive service dealer to increase his own activity. All of these electronic mechanisms must be properly serviced as well as sold and thus we find that the radio service dealer becomes a more important figure in the radio industry.

Photograph shows an RCA Television Engineer preparing a kinescope glass envelope for spraying with fluorescent material.

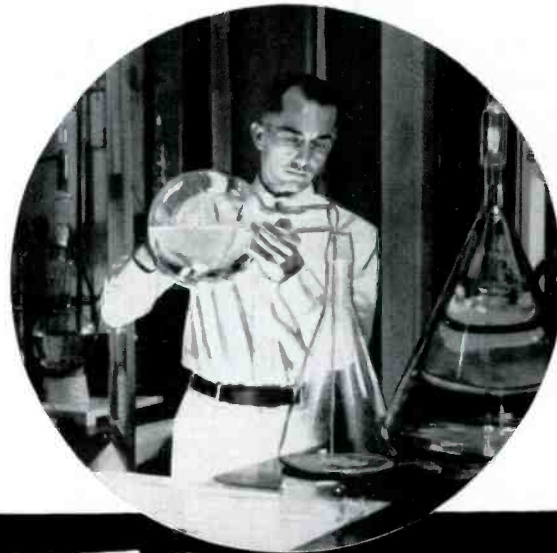

Radio Tubes

FIRST IN METAL
FOREMOST IN GLASS
FINEST IN PERFORMANCE

RCA MANUFACTURING CO., INC., Camden, N. J. • A Service of the Radio Corporation of America

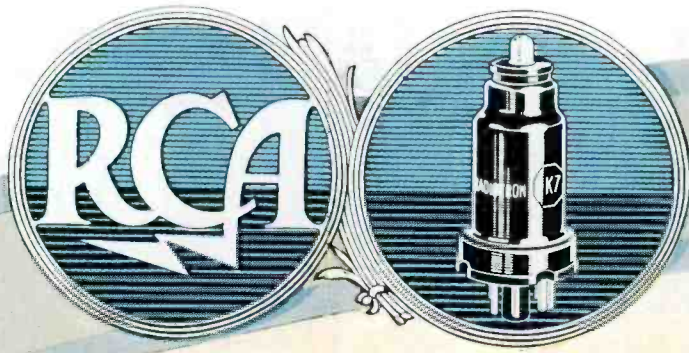

RCA presents the "MAGIC KEY" every Sunday,
2 to 3 P. M., E. S. T., on the NBC Blue Network.

★ **MORE THAN 325 MILLION RCA RADIO TUBE**

THE QUALITY OF

RCA Radio Tubes

IS NEVER QUESTIONED

“Quality,” says Webster’s Dictionary, “is the excellence of character.”

SINCE the beginning of radio, RCA has spent millions of dollars on engineering research in the fields of the electronic art to create and preserve “the excellence of character” that has been built into the hundreds of products that bear the RCA trade-mark.

And so it is with RCA Radio Tubes.

The quality of RCA Radio Tubes has been accepted as standard the world over—

- ... that's why more than 325 million RCA Radio Tubes have been purchased by radio owners.
- ... that's why more than thirty radio manufacturers use RCA Radio Tubes as original equipment.
- ... that's why the majority of broadcasting stations in the United States, as well as leading Foreign Stations, use RCA Radio Tubes.
- ... that's why over 5,000 motion picture theatres use RCA Radio Tubes in their RCA Photophone Sound Equipment.
- ... that's why RCA Radio Tubes are standard equipment in Police, Aviation, Marine and other communication apparatus.

In order to capitalize upon the tremendous public acceptance for RCA Radio Tubes, radio dealers and service men should keep an adequate stock on hand at all times. See your local RCA Radio Tube Distributor.

ES HAVE BEEN PURCHASED BY RADIO OWNERS

YOURS

with the

PURCHASE OF 250 RADIO TUBES*

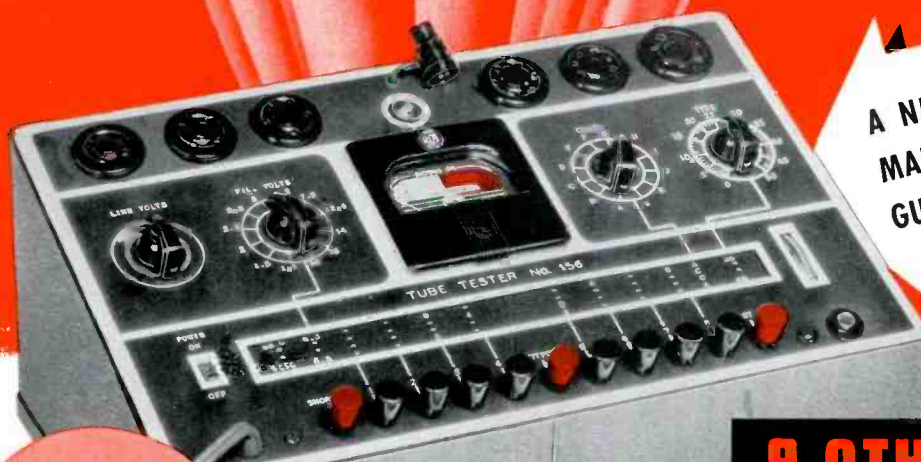

**A NEW TUBE TESTER
MANUFACTURED AND
GUARANTEED BY RCA**

*Tubes purchased must have an average list value of \$1.25



This new RCA Tube Tester offers service engineers, radio dealers, everyone selling tubes, a highly efficient unit that incorporates the experience of the world's largest radio tube manufacturer. New features include testing of 1½-volt battery tubes, magic eye tubes for brilliance, and cathode ray tubes. It is priced at a figure everyone can afford. Stock No. 156-A, Counter Type, \$37.95 net, 250 Radio Tubes. Stock No. 156, Portable Type (with cover), 275 Radio Tubes . . . net, \$39.95

9 OTHER ITEMS

- RCA 3" Cathode Ray Oscillograph, No. 155, Net \$63.95—450 radio tubes
- RCA 2" Cathode Oscillograph, No. 151-2, Net \$49.95—350 radio tubes
- RCA 1" Cathode Ray Oscillograph, No. 151, Net \$39.95—275 radio tubes
- RCA Piezo-Electric Calibrator, No. 9572, Net \$29.95—200 radio tubes
- RCA Universal A-C Bridge, No. 9600, Net \$49.65—350 radio tubes
- RCA Frequency Modulator, No. 9558, Net \$27.50—200 radio tubes
- RCA A-C Test Oscillator, No. 153, Net \$29.95—200 radio tubes
- RCA Electronic Sweep Test Oscillator, No. 150, Net \$64.50—450 radio tubes
- RCA Beat Frequency Audio Oscillator, No. 154, Net \$49.95—350 radio tubes

See your Distributor for complete details



Radio Tubes

FIRST IN METAL
FOREMOST IN GLASS
FINEST IN PERFORMANCE

RCA MANUFACTURING CO., INC., Camden, N. J. • A Service of the Radio Corporation of America

KADETT

International Radio Corporation
Ann Arbor, Michigan

TUNEMASTER — Plug-in connection to any electric outlet—a.c. or d.c.—gives pushbutton remote control tuning on four stations and remote volume control. Converts any radio to pushbutton remote control. Can be taken from room to room, tunes radio anywhere in the home without direct wire connection.

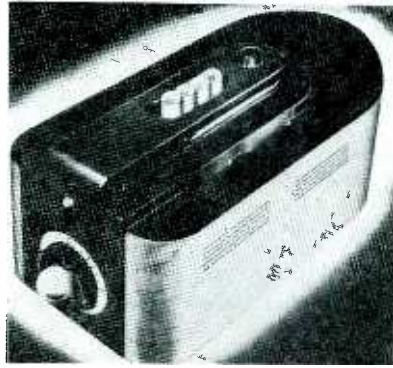

OPERADIO

Operadio Manufacturing Co.
St. Charles, Ill.

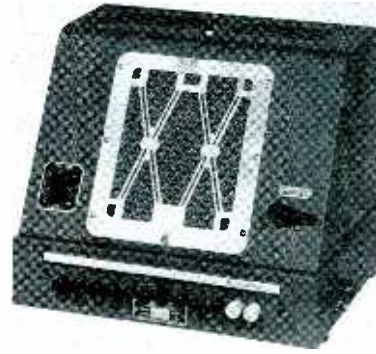

INTERCOMMUNICATOR and Paging System, Model 190, allows Master Station to call any or all outlying stations by means of a master switch. The person called may answer from any place in area where outlying station is located. Outlying stations cannot call or talk to each other.

MEISSNER

Meissner Manufacturing Co.
Mt. Carmel, Illinois

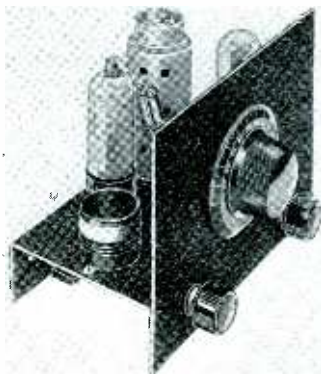

RECEIVER KIT—Simple regenerative receiver kits in one, two, and three tube models, capable of DX reception when used with a good antenna. Headphone reception for one and two tube models, magnetic speaker for three tube set. Octal-based 1.4 volt glass tubes used.

REMLER

Remler Company, Ltd.
19th at Bryant, San Francisco, Calif.



TRANSCRIPTION UNIT—Model PT-192 for service in broadcasting stations and laboratories this unit is designed to be mounted through the control table top. Self-starting, rubber mounted, synchronous motor; speed change by simple lever; high fidelity lateral pickup; adjustable needle pressure

SCIENTIFIC DIATHERMY

Scientific Diathermy Corp.
200 W. 34th St., New York, N. Y.

DIATHERMY APPARATUS—A portable diathermy apparatus advocated by the manufacturer for home use. Automatic timing device.



CLARION

Transformer Corp. of America
69 Wooster St., New York, N. Y.



SOUND SYSTEM—Model C-440 complete sound system includes 24-36 watt beam power amplifier, two 12 in. auditorium speakers, 2 large wall baffles, 50 ft. of cable, choice of one of six microphones, heavy duty floor stand and accessories. List \$129.90. Amplifier only model C-22R list \$42.00

THORDARSON

Amplifier Div., Thordarson Electric Mfg. Co.
500 W. Huron St., Chicago, Ill.



AMPLIFIER — Features tone control; two separate channels incorporating compressor and expander circuit. Three high impedance, high gain microphone channels are separately controlled and may be mixed together or with the high impedance phono channel. 60 watts.

N-U

National Union Radio Corporation
Newark, N. J.

CATHODE RAY TUBE —A new Monotron picture signal generator cathode-ray tube shows a sharp half-tone photograph of a pretty girl in place of conventional test-pattern line drawings.



PREVIEW OF NEW RADIO MERCHANDISE

UNIVEX

Universal Camera Corp.
28 W. 23rd St., New York, N. Y.



CAMERA—"The Mercury" features instrument panel arrangement of controls, every adjustment being made on the front of the camera. Built-in photo-flash synchronizer, 1/20th to 1/1000th of a second speeds, f:3.5 lens. Uses 35mm. film, list \$25.00.

CASCO 75

Casco Products Co.
Bridgeport, Conn.

ELECTRIC SHAVER—Rotary type, operates with brush type interference shielded motor which drives the shearing blades at 4500 revolutions per minute against the circular slotted head. Comb-like safety guard protects the skin and picks up long hair as well as stubble. List \$10.00



ADD-A-BIN

Noggle Products Co.
Ann Arbor, Michigan



STORAGE BINS—System of unit bins sold separately and assembled by the user to fit his individual needs. The bin housing may be screwed to a wall or to a panel which may be fashioned into a portable kit. Bins close automatically, lock open, or may be removed from housing.

SPRAGUE

Sprague Products Co.
North Adams, Mass.

CONDENSERS—"Neutrol", type CR transmitting condensers with flanges for mounting in any position combine oil-filled oil-impregnated construction with handy rectangular sizes. Oil used has a flash-point of 500 degrees F.



C-D—Cornell-Dubilier Electric Corp., South Plainfield, N. J., introduces a complete line of auto filter units constructed to withstand auto temperatures and vibration. Vibrator capacitors are oil treated to stand high surge voltages up to 3000 v.

G E—All-wave multicoupler antenna is the solution offered by General Electric Co., Bridgeport, Conn., for good radio reception in multi-unit buildings. Serves up to 20 radios. For greater numbers, multiple installation can be made. Gives independent reception for each set in the group. Installation includes transformer to be installed in the antenna, lightning arrester and special radio outlet.

JOHNSON—Rotating coupling coil inductors by E. F. Johnson Co., Waseca, Minn., enable exact adjustment of coupling in interstage or output circuits. All sizes will couple into transmission lines of 75 ohms impedance, and this value increases on higher frequency inductors so that 10 and 20 meter types couple into any impedance up to 600 ohms.

SCHICK—The "Colonel" new shaver placed on the market by Schick Dry Shaver, Inc., will retail for \$15.00. Its quick starting motor contains many improvements which increase the power, give higher speed and longer life. The armature acts as a fan to create forced draft and ventilates the motor. Oilless bearings are used with a shaft gauged to two ten-thousandths of an inch.

SOUND APPARATUS—Simplicity of manipulation and reliability of operation were objectives of the Sound Apparatus Co., 150 W. 46th St., New York in designing their mechanism for feeding the recording head across the record. Feeds from outside in or from inside out. Has adjustments for needle pressure and cutting angle necessary to adapt it to any recording head or recording material. For 12 in. and 16 in. turntables.

TUNETTE—Commercial Radio Products, Los Angeles, offer a remote tuning device which plugs into an electric outlet, requires no wiring changes or additions to the radio, offers seven station push button remote control. Contains its own tuning coils, easily adjustable to seven favorite stations. Available in walnut or two-tone walnut and antique white.

BRACH—Electric Fence Control by L. S. Brach Mfg. Corp., Newark, N. J., is portable, weatherproof, dustproof. Case has space for batteries; can be operated on 32 volt farm lighting plant. Filter prevents radio interference. Will electrify 15 to 25 miles of fence. Power adjustable by means of 3-position switch.

UNIVERSAL—A "watch model" single button microphone is designed by Universal Microphone Co., Inglewood, Calif., for detectaphone, inter-office communicating systems and experimental use. Its size makes it possible to conceal it behind screens or grille work, and it can be used as a lapel microphone. List \$3.00.

TRANSDUCER—Transducer Corp. of Rockefeller Center, New York, offers a kit containing necessary components for the construction of 1/2 in. diameter CO-X coaxial cable which includes inner conductor, insulators, outer shieldings, clips, screws, nuts, eyelets and instructions for assembly. Insulating beads are of the Anhygren B ceramic type.

KATO—A new two cylinder, aircooled, 2000 watt a.c. Katolight announced by Kato Engineering Company, Mankato, Minn., generates standard 110-volt, 60-cycle a.c. Self-excited it is furnished with remote control, full automatic control or manual starting. Engine has sensitive governor for close voltage regulation, has high-tension magneto, is completely shielded, and generator is completely filtered.

TINNERMAN—A combination gas and electric range with built-in electric cooker and "Pop-out" valve controls is made by the Tinnerman Stove and Range Company of Cleveland. The electrical element is contained in a built-in compartment. This novel combination range makes it possible to do quick heating and cooking on top gas burners with complementary low temperature cooking on the electric element.

RADIO DEALERS ARE FINDING A *New* SOURCE OF PROFIT IN

SHORT WAVE
Radio-Thermy

At Last . . .

It's here! The sensational Home Radiothermy machine that is sweeping the country! Sells like hotcakes. Every home a prospect. Supreme Model illustrated lists at \$149.50 with a big protected profit to you. Most good jobbers have at least one in stock for demonstration purposes. If he cannot supply you . . . write us at once giving his name and address. Don't wait for Television to boost your profits . . . Radiothermy IS HERE . . . N-O-W! Address Dept. RR-11.

Attractive Territories Open For Distributors



SCIENTIFIC DIATHERMY CORP.
200 WEST 34th STREET • NEW YORK, N. Y.

REMLER

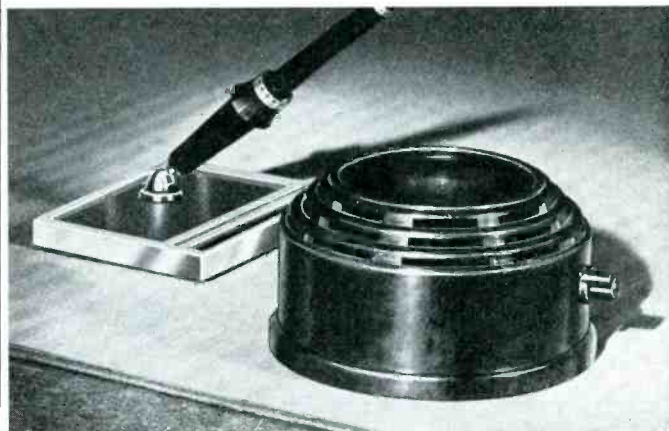

REMLER-PHONE INTER-COMMUNICATION and QUALITY P.A. • TERRITORIES OPEN

Build a permanent business with quality equipment backed by the stability of Remler—continuously in business under the same management since 1918. Unique Remler-phone secondary unit illustrated may be used on desk or wall. It is convenient and attractive . . . like other Remler Inter-Communication equipment it is designed with sales appeal! Write for catalogue and dealer plan.

REMLER COMPANY, Ltd., 19th at Bryant, San Francisco

What's Radio Retailing Say?

If you read it in RADIO RETAILING it is true—and timely.



That goes for both the editorial and the advertising contents of this, the radio industry's recognized leading publication!

RADIO RETAILING

330 W. 42d St., New York, N. Y.

Janette Rotary Converters

For Converting D.C. to A.C.

Built for radio and sound apparatus—capacities 110 to 3250 volt amperes—with or without all wave filters. Dynamotor construction—economical to operate—ruggedly built for years of trouble-free service—used or recommended by the largest manufacturers of radio and sound apparatus—in use all over the world.

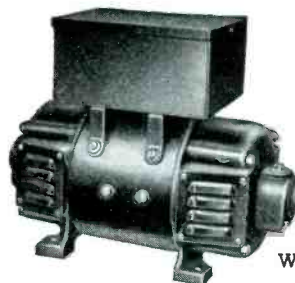

Why Experiment—Insist on a Janette

Ask for Bulletin 13-25

Janette Manufacturing Company

556-558 West Monroe Street Chicago, Ill. U. S. A.



NO HIGH PRESSURE!

NO QUOTAS!

NO DUMPING!

FOR SENTINEL DEALERS!

Sentinel

QUALITY RADIO SINCE 1920

**AC MODELS
FARM MODELS**

A COMPLETE LINE SENSIBLY PRICED

Sentinel Radio Corporation • Dept. RR • 2222 Diversey Pkwy., Chicago

New RADIO PARTS

C-D

FILTERS—For elimination of radio interference from electrical appliances seven types of filters are now available of both capacitor and combination capacitor and inductor type. Can be successfully used with business machines, diathermy apparatus, soda fountain appliances, traffic signals, household appliances, etc.

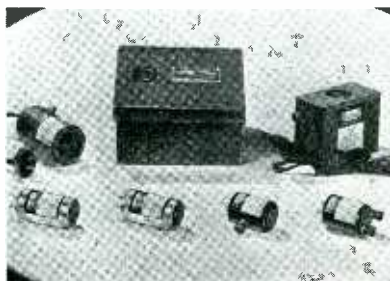

Cornel-Dubilier Electric Corp.
South Plainfield, N. J.

OHMITE

Ohmite Manufacturing Co.
4835 Flournoy St., Chicago, Ill.

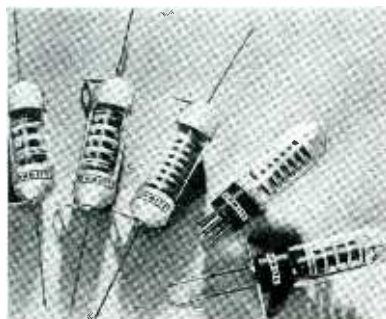

RESISTORS—Hermetically glass sealed precision resistors are non-inductively pie-wound on porcelain in 2, 4, 6, or 8 sections, and enclosed in strong hermetically-sealed glass tubes. One watt rating. Resistances range from 0.1 ohm to 2 megohms.

AEROVOX

Aerovox Corporation
70 Washington St., Brooklyn, N. Y.

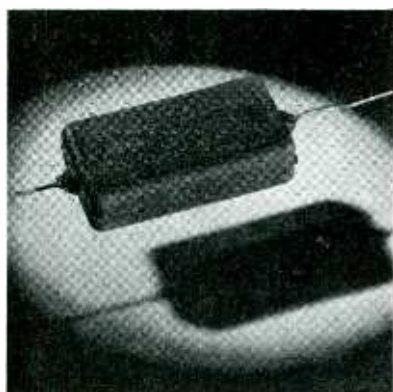

PAPER CONDENSERS—Molded in live rubber jackets which prevent absorption of moisture and safeguard electrical characteristics during molding. Available in capacities up to .25 mfd. in 200-volt, .1 in 400-volt, .05 in 600-volt and .01 in 1000-volt.

GE

General Electric Co.
Schenectady, N. Y.

CAPACITORS—For radio transmitters, Pyranol treated, capacitors are high in dielectric strength, stability and are non-inflammable. Cylindrically cased, hermetically sealed, equipped with ceramic insulators and adjustable mounting bracket. Available in ratings up to 2,000 volts d.c.



TACO

Technical Appliance Corp.
17 E. 16th St., New York, N. Y.

ANTENNA—Peak-Band Antenna especially designed for reception in the 10, 20 and 40 meter bands. Doublet construction is employed for maximum noise reduction.

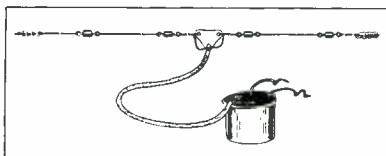

WARD-LEONARD

Ward-Leonard Electric Co.
Mt. Vernon, N. Y.

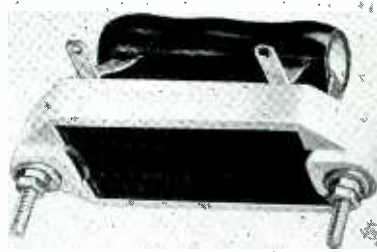

SUPPRESSOR—No. 507-622 for prevention of "parasitics" such as the Tuned-Grid Tuned-Plate oscillating circuit in parallel or push-pull operation of two tubes. Parasitic Suppressor is connected in the tube grid or plate leads to eliminate distortion produced by this type of oscillation.

TOBE

Tobe Deutchmann Corp.
Canton, Mass.

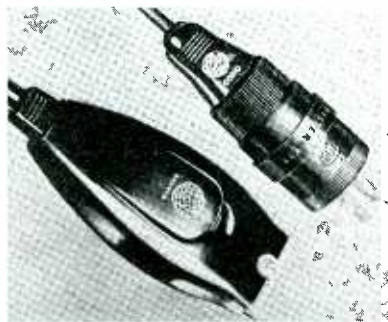

NOISE FILTER—To overcome radio interference created by electric shaving devices, the type R-1 Filterette combines noise reducing efficiency with structural features necessary to meet electric wiring regulations.

MUELLER

Mueller Electric Co.
1583 E. 31st St., Cleveland, O.

GRID CLIP—Insulated assembly made with a Pee Wee Clip having jaws specially constructed to grip and stand erect or horizontally on any size grid cap. Ten in. of rubber covered wire and standard phone tip are supplied also



Latest TEST EQUIPMENT

SUPREME

Supreme Instruments Corp.
Greenwood, Miss.

SIGNAL GENERATOR — Output range of Model 571 is 65 kc. to 20.5 mc. on fundamentals and higher on harmonics. Five bands, iron core coils; 30 or 70 per cent modulation, maximum output .1 volt; handsome metal panel; housed in oak carrying case.



J.F.D.

J. F. D. Manufacturing Co.
4111 Fort Hamilton Parkway, Brooklyn, N. Y.



TESTER — A.c. - d.c. ballast unit tester for 4 and 8 prong types gives direct setting instructions on the meter panel. Immediately shows red light for bad or green for good tubes. Chart lists over 400 tube types and all RMA numbers

TRIPLETT

Triplett Electrical Instrument Co.
Bluffton, Ohio

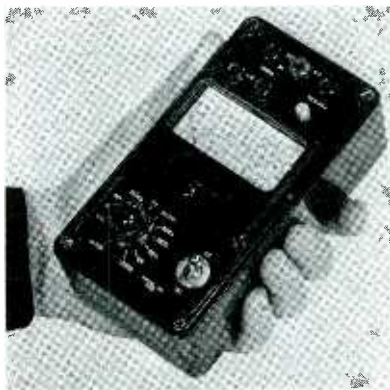

TESTER — Pocket Volt-Ohm - Milliammeter model 666 is designed for a.c. - d.c. voltage, d.c. current and resistance analyses. Ranges are a.c. and d.c. volts 0-10-50-250-500-1000 at 1000 ohms per volt; d.c. milliamperes 0-10-50-250; low ohms, 1/2 to 300; ohms to 250,000 higher readings by use of external batteries.

CLAROSTAT

Clarostat Mfg. Co., Inc.
285 N. Sixth St., Brooklyn, N. Y.

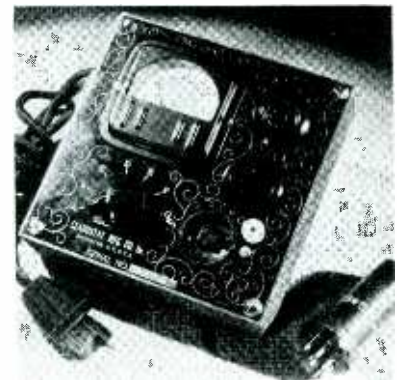

TESTER—Model 160 affords positive means for testing resistor units and line-cord resistors. Panel carries meter or indicator, prong selector switch, octal socket and UX socket for testing resistor units. Selector switch has 8 positions for cutting in on any prong of unit being tested. A.c. outlet receptacle for plugging in resistor line cord

CLOUGH BRENGLE

The Clough-Brengle Co.
Chicago, Ill.

TESTER — Microvolter No. 199 provides a yardstick of receiver over-all performance. Seven in. jumbo Verni-Vider dial, accurately calibrated output of less than 1/2 to 100,000 microvolts at frequencies from 100 kc. to 30 mc. Lattice-wound, non-inductive attenuator resistor

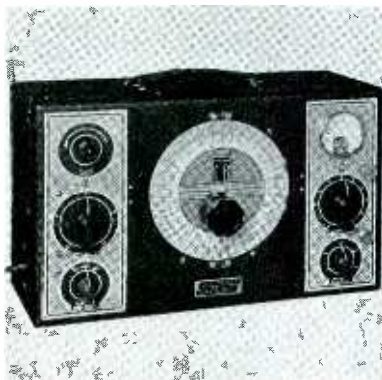

MILLION

Million Radio and Television Laboratories
685 W. Ohio St., Chicago, Ill.



TESTER — Model MOP push button tube tester tests all types of receiving tubes for emission. Short and leakage tests with tubes hot. Dealers' net price \$19.95.

SOLAR

Solar Mfg. Corp.
599 Broadway, New York, N. Y.



CAPACITOR ANALYZER—Model CC measures capacity .00001 to 800 mfd., including motor starting condensers. Measures Power Factor 0 to 50%, including motor starting condensers; resistance 50 to 2,000,000 ohms; insulation resistance to 1000 megohms. A.c. operated.

RADIO CITY

Radio City Products Co., Inc.
New York, N. Y.

SIGNAL GENERATOR — Model 701 a.c. generator provides output from 1 microvolt to 1/2 volt on frequencies from 125 kc. to 90 mc. Five bands; direct reading dial; 30 per cent modulation at 400 cycles; completely shielded.





1

By **ARTHUR JOSEPHS**
Winner, First Prize (Class A)
"Radio Retailing's" Tube Sales Ideas Contest

PEOPLE would rather buy radio tubes than radio service. I became familiar with this fact shortly after entering the service business when a customer objected to my very reasonable \$3.50 service estimate shortly after he had willingly spent \$11 for a new set of tubes elsewhere.

He said he preferred paying \$11 for a staple, nationally advertised article than \$3.50 for "just service". I started explaining how he pays the doctor and the lawyer for service and he replied that "a doctor is a doctor and a radio man is a radio man. At least I get something definite for my money when I buy tubes, even if they don't fix the set. I would have needed them later anyway. The ads in the magazines say nearly all troubles are due to tubes. I know nothing about resistors and condensers which you mention but I do know what a tube is. It's not that I mind so much paying for service but I would much rather pay for tubes. If you were smart, you would sell tubes instead of service and receive your profit from your percentage on the tubes."

This seemed foolish at the time, but I decided if that is what people want why not give it to them? Ever since then, I don't sell service, nor do I sell tubes, but rather I let the tubes sell my service work for me. They sell service with far less resistance than the service work could sell itself. I always receive a greater net profit per job and exceedingly more customer satisfaction. I needn't mention what happens to tube sales with this method.

After some evolutionary trials,

my system has resolved itself into the following, applicable, of course, only on jobs which can legitimately use a new set of tubes:

I give three separate estimates. Number 1 is the regular, ordinary service estimate, without any tubes. Number 2 is the list price of a new set of tubes plus number 1. Number 3 is a carefully planned figure which is more than the list price of tubes but which immediately makes apparent a definite cash saving over the legitimate but nevertheless high priced estimate number 2. The profit percentage of the tubes in number 3 must more than cover my profit as of estimate number 1, the service work done alone.

By this method I make apparent to the customer an actual saving on service work. This is ordinarily difficult to accomplish because radio service is not an anticipated expense and so is never figured in the family budget. It is considered an added burden, a lessening of which is decidedly welcome. This saving factor, plus the fact that tubes are the only part of a radio which people have been trained to buy by powerful national advertising, makes my estimate very difficult to reject, and my tube sales reflect this condition directly.

. . .

HERE is an idea that sold many tubes for us and brought many new customers to our store.

I had been saving discarded tubes for window display and had gathered close to a thousand. I conceived an idea to use these tubes otherwise and this is what I did:

I had cards printed with a drawing of an animated radio tube, the face of the radio tube had a pleading downcast expression and was humorous to look at. Alongside the tube figure was the following wording. The heading read: "You can't blame me for trying." Underneath, in smaller print it read: "I have been thrown out of the

4 WAYS

radio home in which I lived. I caused noise, whistling, fading and squawking and the people who owned the radio would not put up with me any longer. Could you find a new home for me in your radio, or have you tubes like me in your set right now that you should throw out?"

Our store name and address



2

By **WILLIAM J. BAUER**
Winner, Second Prize (Class A)
"Radio Retailing's" Tube Sales Ideas Contest

covered the bottom of the card with our radio service and tube sales ad. These cards were fastened to the old tubes by means of a stout string and one was hung on each door knob in a selected territory. The people who responded, both old and new customers, saw the plan to be most humorous and convincing.

I wish we had been able to use 5000 old tubes in this plan.

. . .

THE entire effort in tube selling must be directed to make the customer's "no" impractical.

(a) In servicing the set in the home, unless complaint or manifestation is otherwise, first test the tubes. Then, without report to the customer, proceed to the truck and bring back a complete new set of tubes and set in prominent place on top of a console radio or beside

T O S E L L T U B E S



3

By L. W. HATRY

Winner, First Prize (Class B)
"Radio Retailing's" Tube Sales Ideas Contest

a table radio and, with the old tubes in one's hand, say:

(b) "Mrs. X, where shall I throw the old tubes, in the wastebasket, or shall I carry them out? . . . Yes, some of them test pretty good but they are old, two years or more, and service calls cost more than tubes in the long run. . . . Yes, you might keep some of the better ones for spares."

(c) (Compromise, full-pay improbable) "Why not buy four of them (half) now? I'll put in the better of the old ones temporarily and come back (definite date) to replace the rest, that will make it easier to handle. I should like to come back to make certain everything is satisfactory."

(d) The set needed shop repairs so in it came. The tube sale and the repair sale should be as independent as the motor repair as contrasted with the purchase of a set of tires.

(e) "Mrs. X, this is the Y Radio Company calling about your radio. . . . Yes, Mr. X. I wonder if you wish me to discard those two year old tubes of yours here or you'd rather I saved the better ones and let you have those for spares? . . . The new set of tubes is only X dollars and will avoid calls and unnecessary labor expense and save their own cost. . . . Only four are

hopeless but the rest are just as old, although passable."

(f) Not till the tube sale is made or killed, discuss the repair problem. Customer's identification of tubes with repairs guarantees full attention on the tube sales effort. You should work the talk to indicate the independence and necessity for repairs. The repair job *must* be done, the tube sale is less necessary so *must* be worked on.

(g) With rare exception, the cross-counter sale is to the economizer who brought his tubes for test to "save". He came in determined to buy only one tube if possible. I haven't licked him yet.

* * *



4

By JERRY SHIREK

Winner, Second Prize (Class B)
"Radio Retailing's" Tube Sales Ideas Contest

BIGGER tube sales mean greater profits, providing there is not too great an expenditure of time and money. Any tube dealer can increase his volume of tube sales and do so with profit by means of a convenient, practical and economical system which I have seen in successful operation.

The first requisite if you wish increased tube profits is to become tube sales conscious. Convince yourself and the members of your organization that you are doing the

customer a greater favor by improving his reception than you would by sparing his pocketbook. Remember: "Quality is remembered when price is forgotten."

With this in mind, make your new tube recommendations upon the delivery of each repair job. If the customer fails to buy all the tubes you recommend at this time, it may be due to the fact that the total bill would be beyond his present financial ability. Make out a postcard, post-dated 30 days with a message similar to the following and file it in a dated file. When the date arrives simply mail it:

Dear Sir:

We repaired your radio 30 days ago, and not having heard from you we trust that our services were satisfactory. At the time we recommended that you renew the following tubes: 1-24, 2-45, 1-80. The changing of these tubes will further improve the tone of your radio, make it less likely to develop trouble, and reduce noises. If you are ready for these tubes now, we will be glad to install them, labor-free, as no further testing will be necessary. Hoping we may continue to serve you, we remain.

Yours truly

Another effective card follows. This is to be mailed on the first of the month to all customers who have not been heard from during the past 12 months:

Dear Sir:

Our records show that your radio has had no attention for a year. To avoid trouble and to keep down static and noise, it is wise to have us test the tubes even though the radio seems to be operating well.

There is no charge for this if you bring in the tubes. Service in the home is \$1.00.

"An ounce of prevention is worth a pound of cure."

Yours truly

NEXT MONTH

*More Good Tube
Sales Ideas*

FIRST AID *f o r*

By CASWELL ODEN

THE outside salesman who has never done any inside selling quite often has the idea that inside selling is just about the softest job any salesman could ask for, that it amounts to nothing more than taking orders. After all those tough nuts he's had to crack outside—many of which he had to sell not only the merchandise but the idea of wanting it—it certainly would be nice to merely *wait on* people; talk to nothing but *hot* prospects; deal only with people who walk into the store of their *own volition*—thereby proving that they are ready to buy.

But if he ever is given the opportunity to work inside he quickly discovers that all is not gold that glitters. It is very true that the quality of his prospects, on the whole, is higher. But he runs up against certain other circumstances which he had not considered. And after a few "hot" prospects have walked out on him without buying, he stops and scratches his head. "Hmmm, this isn't so easy after all!"

He discovers, among other things, that in the store a prospect can say "Well, I'll think it over" and then start for the front door. And to the salesman's great astonishment and chagrin he discovers that there is not a *thing* he can do about it!

There was plenty he could do about it on the outside. When a person said, "Well, I'll think it over," he simply *helped* the person to think it over. In fact, he kept right on helping until the person thought himself into buying.

If he has any conceit at all he doesn't like to fail to sell what he enjoys calling a pushover and this sudden turn of events may injure his vanity. But if he is strictly a salaried man he probably won't lose

any sleep over it. Just window-shoppers, that's what they were. Why let a little thing like that worry *him*? *He's* sold *tough* customers, and you can bet your life that if a *good* prospect walks in he'll sell him.

However, if our man happens to be getting some kind of sales commission as well, no matter how small, he'll do a lot more than merely scratch his head. He'll give the matter some very serious *thought*. He'll half-admit to himself, that some of those people who walked out on him should have been sold. And he will try to figure out the reason why he didn't sell them.

If he is any kind of an analyst—and he is, or he wouldn't have been a good salesman on the outside—he'll discover that, in a word, inside selling has its own peculiar technique, and he will begin to develop that technique.

(Moral: Not only this man but any inside salesman should receive some kind of commission on all his sales.)

The Right Way to Demonstrate

This difference in technique applies to practically everything we are called upon to sell inside. But it applies very drastically to the selling of radios for *three* reasons: (a) Our method of handling the prospect is different—no pressure. (b) We may find it advisable to sell a home demonstration instead of a set, and (c) There is a difference in the demonstration (physical demonstration) of the set itself.

Let's take the demonstration of the set itself first.

Radio reception is not as satisfactory in the average business district as it is in a residential district. Assuming that our store is in a business district, we are at a disadvantage right away. When we demonstrate a set and it is noisy, we lose a sale. It doesn't do a bit of good to explain *why* it is noisy. We might as well save our breath. If we tell the prospect about all the interference outside, and how much better the set will sound in his home, he agrees with us. But he doesn't buy the set. He knows only one thing. The set is noisy. It will be noisy anywhere. (Believe it or not, the only time it does any good to explain about the interference outside is when the set is *not* noisy!)

So our main problem, then, is to not get any static, or at least cut it down to a minimum. So important is this that some inside salesmen put their finger on the aerial post and use their body for an antenna, but if we use a good noise-reducing antenna we should get very satisfactory results in the store—provided we don't try to get too much volume.

In no case should we worry about volume. The prospect already knows the set will be loud enough. In the store we must concentrate on tone and clear reception—and nothing else. Our prospect is in the habit of listening to sets out in the suburbs, perhaps, and we have got to compete with such reception. And our best chance to do it is, to keep the volume low.

Just what we should do about police calls and foreign reception is a problem. What we should do depends, largely, on the prospect and on the kind of reception we are getting on the day in question. I can, however, be very specific on two points. Foreign reception, demonstrated in the store, has lost more sales than anything else I know of. You'll lose fewer sales by not getting the foreign reception at all than you will lose by getting it with a lot of static.

There is no set rule to be given.

EDITOR'S NOTE

Widely read, and applied by many retailers with a salutary effect upon business, were the radio-refrigeration sales ideas advanced by the author in his April-August series about Outside Selling. "Now, how about help on Inside Selling?" other readers wrote. We passed this logical request along to Oden, present the excellent article which follows as a direct result.

BEGINNING NEXT MONTH—First of three articles dealing specifically with the sale of refrigeration by radio dealers.

t h e F L O O R M A N

We must simply use our own judgement in each case. But our judgement should be swayed, and swayed heavily, by the two points I have mentioned.

Six Points to Remember

So much for the demonstration of the set itself. Now let's take care of a person who has just walked into the store and asked to look at a radio.

There are a number of points we should bear in mind, while we are walking over to greet this man, and I believe they should be itemized, before dealing with them, separately, and in detail.

(1) He must not hear any static, or as little as possible. (Already covered)

(2) We use no pressure at all.

(3) We must show no preference for any particular model until we discover which one *he* likes best. Then that's the one we like best too.

(4) Ace up sleeve: Demonstration in his home.

(5) Last resort: Name and Address.

(6) He can walk out whenever he pleases.

Now when we walk over and say, "How do you do—may I help you?" we've got all these points in mind (subconsciously, of course, after a little experience), and we know that, as we go along, the prospect himself will determine for us the importance of each point and just what part it will play.

But some of these points overlap, intermingle, depend upon each other to such an extent that it is not the easiest thing in the world to isolate each point and talk about it apart from the others. I'm sure you will bear this in mind as I take a stab at it.

(2) Most any prospect, no matter how "hot" he is, usually has to be pressured a little, but here's a man who has walked in to look at a radio, and we are not going to pressure him at all. Why? For no other reason than that we are *in the store*.

Inasmuch as he walked in *without any solicitation*, why should we pressure him? We simply *know* he's going to buy. Our whole attitude

should be that there is *no need* for any pressure. We simply *assume* he's going to buy. The problem is merely one of *selection*—you might believe from watching us!—and very courteously we are going to help him make that selection.

The nearest we'll ever come to pressure is this:

If we have demonstrated a certain set, and the man seems to like it, and we are practically *sure* we can sell it—then we can walk nonchalantly over and pick up a pad of contracts. We walk back, drop the contracts on the radio, take out our pencil, and prepare to do a little figuring.

"Let's see how this would figure," we say. We already know how it will figure. But we are testing him out; we want to see how he will react if we act just a *little* like we intend to sell him.

If he tests out all right, then we can become a little bolder and say, "About how much were you figuring on paying down?"

But all the time we have been leading up to this point, mind you, and even while we stand there asking him how much he was figuring on paying down—we must not have *committed* ourselves.

And this is what I mean by not committing ourselves: Not once while we are talking to this man do we **OBVIOUSLY** try to *sell* him the set. Because . . . but this takes us into point No. 4.

An Ace Up Your Sleeve

(4) Our ace up our sleeve is a demonstration in his home. And the demonstration is a very good ace, *before* we have tried to sell. It is absolutely worthless *after* we have tried to sell.

The reason for this should be clear. If we try for a demonstration after trying to sell, the gentleman not only feels certain that the trial will obligate him, but knows that we are making the suggestion as a last resort. But, if we try for the demonstration before trying to sell, there are plenty of cock-and-bull stories that we can give him concerning why he should try the

(Please turn to page 64)

6

POINTS TO REMEMBER

when a prospect enters the store

1. Reception must be clear, tone good, "static" absent. *This is best accomplished by keeping volume down*
2. Pressure which might be permissible outside must not be used. *Assume that anyone who comes in actually intends to buy*
3. Show no model preference until your prospect does. *Then infer that it is the one you like best too*
4. Hold home demonstration up your sleeve as an ace. *Don't shut this door by trying too hard to close*
5. As a last resort, get the prospect's name and address. *This will permit follow-up by the outside staff*
6. *Above all, remember that a prospect who enters the store of his own free will can walk out whenever he pleases*

RCA Victor

TIME-SAVING, PROFIT-PACKED

Phone SYSTEMS!



Two types are available—a wireless system for instant 2-way inter-office communication... a wired system for 1 to 5 channel communication! Both sell at reasonable cost—assure you worth-while profits.

Designed to meet the time-saving requirements of modern business, these RCA Victor phones will appeal to a tremendous market—a market you can sell.

Practically every place of business is a prospect. Auto dealers, banks, dentists, doctors, factories, hospi-

tals, police stations, schools, and dozens of others!

Not only do these two RCA systems offer many excellent sales features, but both are moderately priced. Order your supply now—and climb aboard this plus-profit wagon!

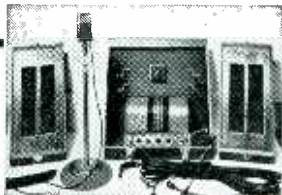

RCA PG-112 PORTABLE P. A. SYSTEM

... another money-making item!

Illustrated above, this system is universally adaptable. Operates from 110 AC or 6-volt storage battery and dynamotor. Permanent or mobile installation, 12 watts output. Two powerful dynamic speakers with RCA Velocity Microphone. This highly efficient system is excellent for scores of locations where good sound is paramount. Besides its many selling features, the PG-112 is low in price—only \$199.50.

Have you secured your copy of RCA's new sound catalog? If not, be sure to get it from your distributor, or write direct to us in Camden, N. J.

RCA presents the Magic Key every Sunday, 2 to 3 P. M., E.S.T. on the NBC Blue Network

Model MI-6350 illustrated above, is as simple as it is effective. Your customer simply plugs into the light socket (110 volt AC or DC) presses a button, and talks. No wires, no batteries, no installation at all. Works perfectly at all times.

In addition to the wireless system illustrated, RCA Victor also offers a master phone system for 1, 2, 3, 4 and 5 channel communication, which will be particularly popular in business offices. Speech is clearly heard up to 25 feet from the loudspeaker. Further information from distributor.

Any sound system sounds better equipped with RCA Radio Tubes



Commercial Sound

RCA MANUFACTURING CO., INC., CAMDEN, N. J. A Service of the Radio Corporation of America

WARNING!

An Important Message to the Dealer Relative to the "Steem-Electric" Iron

The Steem-Electric Corporation

WILL PROSECUTE

to the fullest extent of the law any Maker, User, or Seller, of any Iron that Infringes Our Patented and Trade-Marked

STEEM-ELECTRIC IRON

U. S. Patent No. 2027767 Trade Mark Registered

STEEM-ELECTRIC CORPORATION

1720-26 Lafayette Ave. St. Louis, Mo.



SMOOTH... QUIET... DEPENDABLE

"PINCOR" offers the only complete line of "B" power supply equipment for police units, aircraft and radio broadcast service and sound systems. Frames, sizes and capacities to fit any requirement.

"PINCOR" dynamotors are the last word in efficiency and regulation. Deliver high voltage current for proper operation of your apparatus with a minimum of A.C. ripple. Compact, light weight. With or without filter. Send for catalog.

PIONEER GEN-E-MOTOR CORPORATION Dept. R-1K, 466 West Superior Street, Chicago, Illinois



Without obligation kindly send me "PINCOR" Silver Band Dynamotor catalog and data sheets. Name Address City State Also send me Converter Catalog.

RADIO RETAILING

**EXTRA Features About
TEST EQUIPMENT
and PARTS**

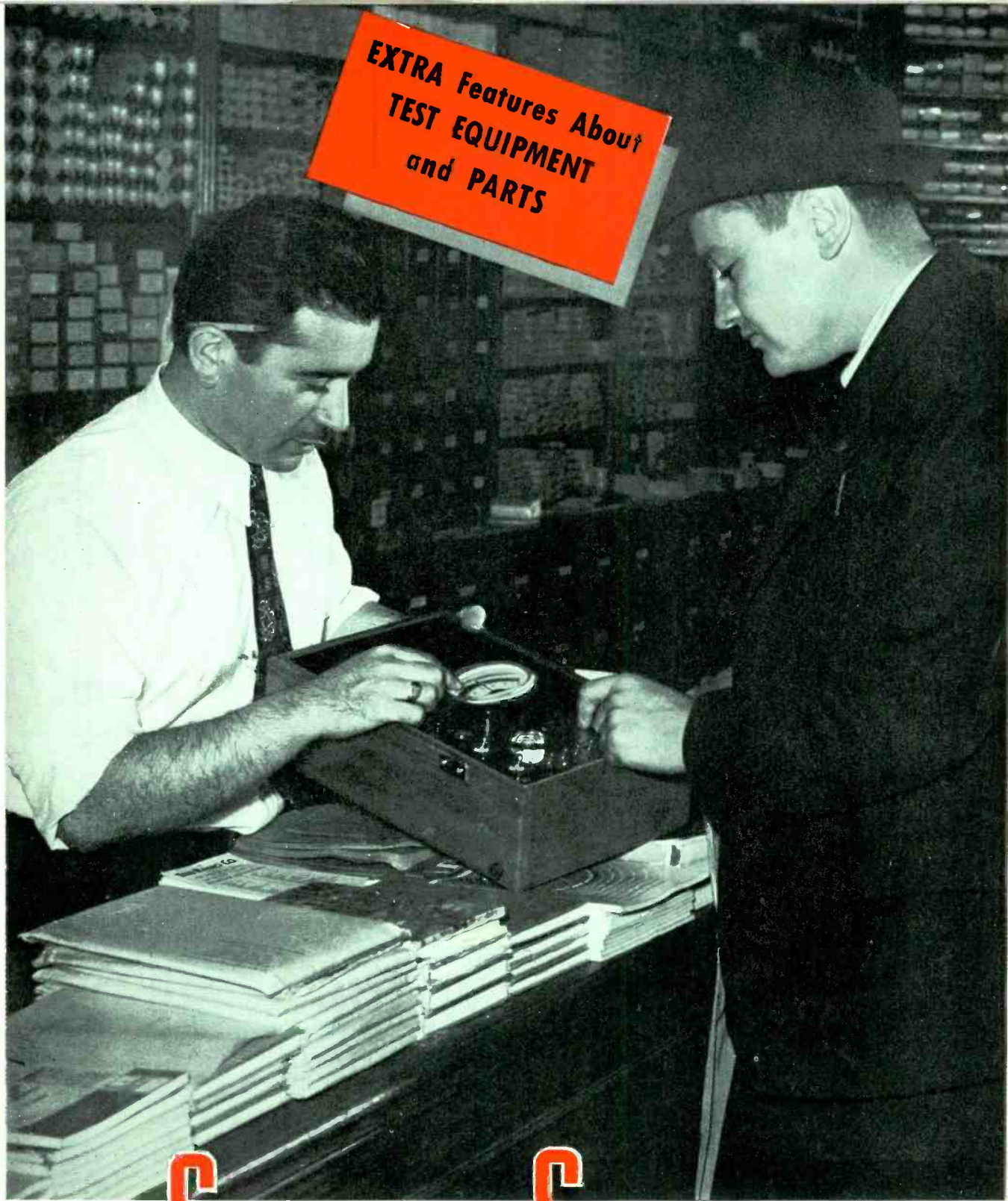

Selling Service

**IN THIS ENLARGED SECTION: How to Pick Your Parts Stock...
Test Equipment Every Serviceman Needs... Shop
Modernization Ideas... News and New Products for the
Technician... Circuits... Shortcuts... Tricks of the Trade**

How to Maintain a Good REPLACEMENT PARTS With a Minimum Investment

WHAT is an adequate parts stock for the radio serviceman? Requirements naturally vary with location and size of operation but it is possible to state an average minimum.

Our company has studied this problem and the itemized list which follows is suggested as that minimum. Based on 20 repair jobs each week and corrected for seasonal variation, its total cost is under \$150. It should be possible for the average serviceman to get by with such a minimum stock. Less will generally be false economy and more is desirable if the operation can afford the additional investment.

Fully 80 per cent of all service jobs can be handled by the average serviceman with such a stock of essentials. We have not included such parts as speaker cones and fields, i.f. and r.f. transformers and Class B audios as these vary considerably with respect to type. Turnover is slow, insofar as replacement use is concerned, so they may be ordered from local jobbers when needed if investment must be kept down to absolute rock-bottom.

Despite the fact that parts jobbers are generally close at hand and render quick service we would recommend that servicemen stock at least the parts list we recommend herewith, regardless of whether he is a hundred miles away from his distributor or only two blocks. As an example: One of our local servicemen carries practically no parts stock. He averages three calls a day at our counter. Although only a few blocks from us, each call costs him at least 15 minutes of time, 45 minutes a day. Maybe, this is only 75 cents time cost if he figures his time as low as a dollar an hour. This amounts to over \$200 worth of time a year. And he is a busy man. Many times, in congested areas, this 45 minutes a day can run up to two or three hours. Very costly.

As to perpetual inventories: We give our customers "want cards." These hang over their benches. Each

item used is jotted down. Saves our salesmen time, too.

Experience shows us that, next to seasonal pickup in the fall months, moisture helps the service business most. July and August with thunder storms. Fall rains. Humid air causes parts to pop off right and left. During Elmira's flood of 1935, more radios broke down that were never touched by water than were actually immersed. That same thing has just happened in the New England states.

Mechanical parts such as volume controls pop off later in the year. November, December and in April and May. They just naturally lay down after a hard winter of twisting by the family. Vibrators, similarly, are most apt to fail after a summer of motor trips.

Here's our recommended minimum list:

CONDENSERS

Electrolytic

- 6 small 8 mfd. cardboard 450 wv.
- 3 small 4 mfd. cardboard 450 wv.
- 3 1½ inch 8 mfd. can 450 wv.
- 1 1 inch 8 mfd. can 450 wv.
- 2 dual 8 mfd. cardboard 450 wv.
- 1 25 mfd. 1½ inch can 450 wv.
- 3 small 8 mfd. cardboard 200 wv.
- 2 small 16 mfd. cardboard 200 wv.
- 1 small 25 mfd. cardboard 200 wv.
- 1 5 mfd. 50 v. cartridge
- 1 10 mfd. 50 v. cartridge
- 1 25 mfd. 50 v. cartridge
- 1 dual 5 mfd. 35 v. cartridge

SERVICE CALLS BY TYPES *

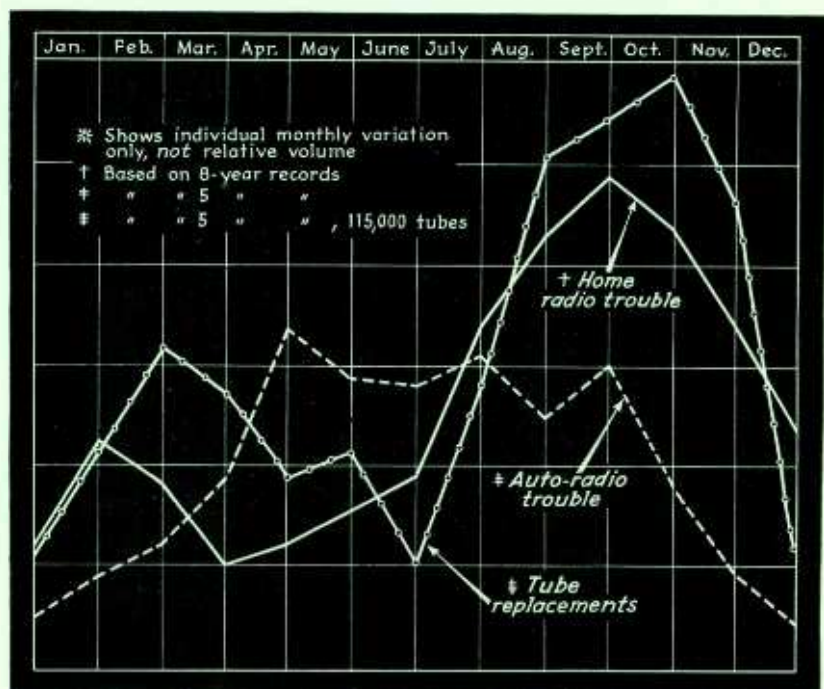

STOCK

By **HAROLD F. JENKINS**

*Fred C. Harrison, Parts Distributor
Elmira, N. Y.*

By-pass

- 6 .5 mfd. 600 v. cartridge
- 6 .25 mfd. 600 v. cartridge
- 10 .1 mfd. 600 v. cartridge
- 3 .06 mfd. 600 v. cartridge
- 10 .05 mfd. 600 v. cartridge
- 2 .04 mfd. 600 v. cartridge
- 2 .03 mfd. 600 v. cartridge
- 6 .02 mfd. 600 v. cartridge
- 10 .01 mfd. 600 v. cartridge
- 2 .006 mfd. 600 v. cartridge
- 4 .005 mfd. 600 v. cartridge
- 2 .004 mfd. 600 v. cartridge
- 2 .003 mfd. 600 v. cartridge
- 2 .002 mfd. 600 v. cartridge
- 4 .001 mfd. 600 v. cartridge

Micas

- 2 .0001
- 1 .0002
- 3 .00025
- 2 .0005
- 1 .00001
- 1 .00005

Buffers (Auto)

- 2 .05 mfd. 1000 v. cartridge
- 2 .01 mfd. 1600 v. cartridge
- 2 .02 mfd. 1600 v. cartridge
- 2 .005 mfd. 1600 v. cartridge

Total net cost of the above minimum condenser stock would average less than \$32. Stock should be increased by 50 per cent during July, August and September. (As pointed out in an earlier paragraph this recommended minimum is for a shop handling an average of 20 calls per day.)

RESISTORS

* 1 watt 1/2 watt	10 watt	25 watt (Variable)
2 100 ohm	2 100 ohm	1 500 ohm
2 250	2 250	1 1000
2 500	2 500	1 5000
2 750	1 750	1 10,000
2 1000	2 1M	1 15,000

VOLUME CONTROLS

(All controls straight, no taper, those marked * should be with tone-compensating tap at 50% rotation point.)

- 1 500 ohm
- 1 1000 ohm
- 1 5000 ohm
- 3 10M ohm

- 2 1500
- 2 2000
- 4 2500
- 2 3000
- 2 4000
- 4 5000
- 2 7500
- 6 10M
- 2 15M
- 2 20M
- 2 25M
- 2 35M
- 4 50M
- 1 75M
- 3 100M
- 1 150M
- 2 200M
- 2 250M
- 4 500M
- 2 750M
- 4 1 meg.
- 2 2 meg.
- 1 3 meg.
- 2 5 meg.

* Same stock of each size advisable.
Total net cost, approximately \$28.60.
Increase stock 50%, August, September, October.

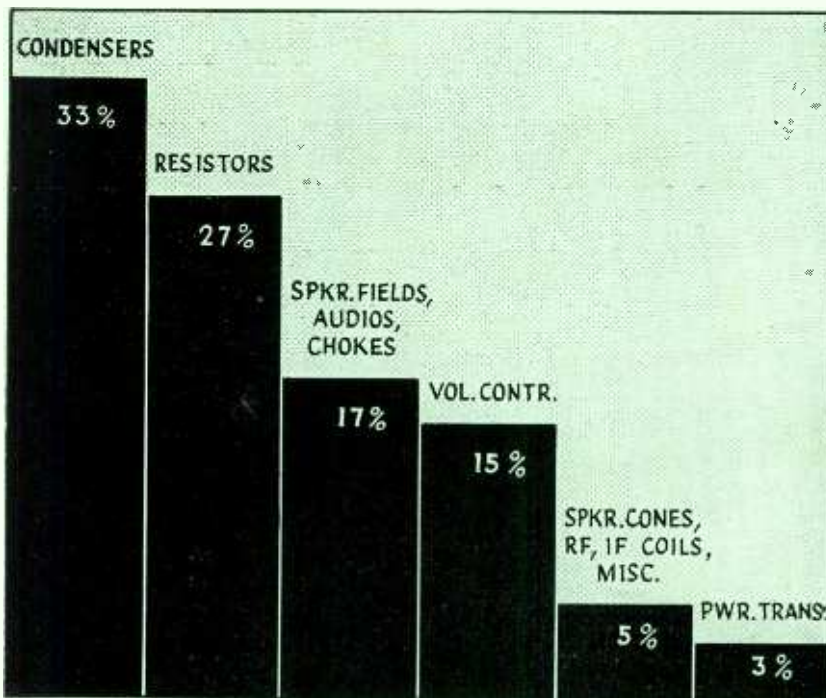

CAUSES OF RADIO RECEIVER TROUBLES—Shows relationship in units, not dollars. Tubes and vibrators excluded

- 1 25,000
 - 1 25M ohm
 - 2 50M ohm
 - 1 100M ohm
 - 1 250M ohm*
 - 3 500M ohm*
 - 3 1 megohm*
 - 2 2 megohm*
 - 6 switches for controls (ratio 1:3 use them)
- Net cost \$15.90. Increase by 50% in November, December, April and May.

AUDIOS, CHOKES

- 1 200 ohm choke for AC-DC's
 - 1 800 ohm, 35 h, 25 ma.
 - 1 350 ohm, 30 h, 75 ma.
 - 1 Single input
 - 3 P-P inputs
 - 2 Universal outputs
 - 1 Midget type p-p input
 - 1 Midget type universal output
- Average net cost, \$11.45. Double stock in July, August.

Miscellaneous Auto Parts

- 50 foot 3/8 inch shielding
 - 24 Universal type suppressors
 - 4 Distributor supp. (plug in type)
 - 3 .5 mfd. metal case gen. condensers
 - 6 Wheel static springs
 - 6 Assorted vibrators, most popular for prevailing makes. Varies with location.)
- Net cost, \$25.00. Double stock in May, June, July.

What TEST EQUIPMENT Do You Need?

Fig. 1—WHERE TO TEST— Overall set distortion may be checked by connecting oscillograph vertical posts at CR2, feed tone modulated signal generator in at SG3; then with oscillograph sweep oscillator set at 1000-2000 cycles, check for uniformity of waveform on screen. **INTERMITTENTS—**To localize trouble in such sets leave modulated signal generator at SG3, oscillograph at CR2. When intermittent causes set to go dead, move oscillograph up through points 1, 2, 3, 4 and 5; endeavoring to find stage where signal reappears. **ALIGNMENT —** Connect signal generator, frequency modulator and oscillograph as shown. Vertical posts of oscillograph go to CR1, signal generator to SG1, SG2, SG3; align i.f. transformer following signal generator.

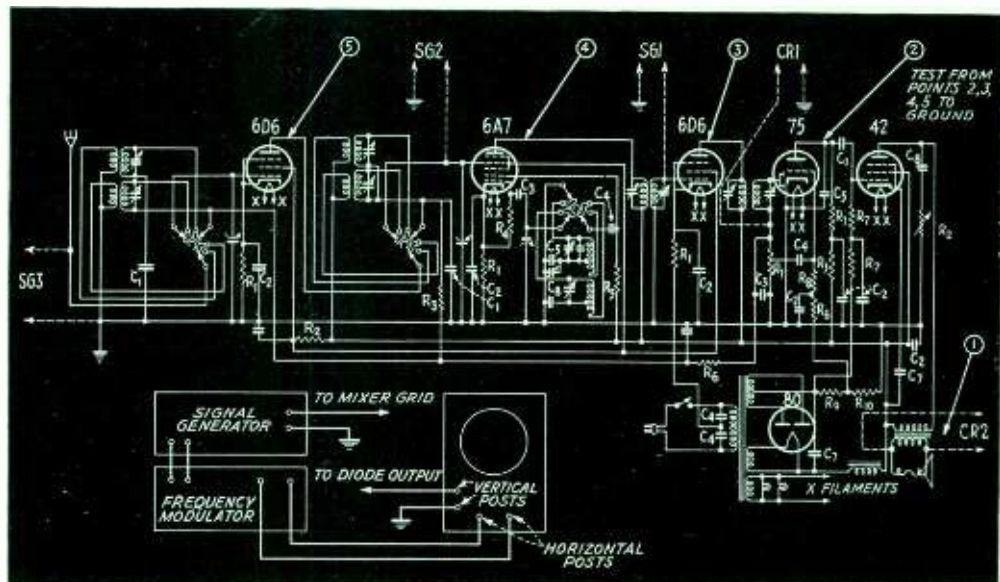

By C. A. NUEBLING

TEST equipment, like other service necessities, should conform with the size of your business if a livable profit is expected. Undoubtedly, if servicing keeps you busy only part of your waking hours your instruments are few. A full time man should have at least the basic units. Likewise, the service store should have additional equipment.

Don't get me wrong! Of course we'd all like to, and should have sooner or later, every available test instrument at our finger-tips. On the other hand, if most of us tried to buy these all at once we'd soon find our creditors at our tail. The logical way, then, is to acquire essential instruments first, then expand our equipment as business and income increase. Since you only have two hands, it stands to reason the quicker you can do a job, the more jobs you can do; consequently the greater profit. Although I've seen old-timers who were uncanny at wielding a screwdriver, it nevertheless is a fact that

good test equipment is the surer and quicker method.

With this point in mind then, we can determine what equipment is necessary to make a bread and butter profit for all involved.

Essential Instruments

The constants that make up a radio are voltages and current flowing in resistance, capacity and inductance. When testing a set, it is basically necessary to check these factors to determine whether they are of the values predetermined by the designer. Since capacity and inductance values are comparatively stable; (usually only the d.c. resistance of these units is of prime importance to the serviceman) voltage, current, and resistance measurement therefore are the keys to servicing. Thus the multimeter should probably be the first instrument.

At this point the embryo serviceman realizes that its inconvenient to take tubes down to his parts jobber

every time he suspects a bad one. Also, he learns that he can make a little extra profit on replacement tubes. Obviously then, the second instrument if not the first to be purchased is a modern tube tester.

Months later we see our hero futilely biting his nails (which are already down to the first joint). A friend brought in an intermittent set; casually remarking, "I found some loose screws (the trimmers) on top of the shield cans, so I tightened 'em all down; but still it won't work!" Under these conditions a signal generator is at premium. Of course you could try to borrow one, or let another serviceman line it up; but the wise man will empty his dime bank and scurry to the nearest test equipment dealer. With a signal generator in your possession and the ability to use it, you can begin to call yourself a serviceman.

Before we go further, an analyzer or set tester should be part of your test equipment. It could be the first in-

**CHANNEL TESTING
DYNAMIC TESTING
STAGE BY STAGE**

**NO MATTER HOW
YOU TEST . . . you
need an oscillator that**

*won't
drift!*



**Here's the Oscillator with
automatic amplitude control and hand calibrated
dial . . . that doesn't drift,
that's guaranteed to hold
its accuracy.**

only **\$65²⁵**
NET

TO SERVICEMEN IN U. S. A.

WESTON

DIRECT READING OSCILLATOR

See this Model 776 Oscillator at your jobber's today, as well as the inexpensive WESTON Vacuum Tube Voltmeter. Or, return coupon immediately for complete information.

Weston Electrical Instrument Corporation,
581 Frelinghuysen Ave., Newark, N. J.

Send literature describing Model 776 Oscillator and 669 Vacuum Tube Voltmeter

Name.....

Address.....

City..... State.....



Fig. 2—VIBRATOR OSCILLOGRAM—Waveform of a good auto vibrator. Flat-topped curve indicates positive contact of points. Magnitude of sharp corner peaks are tell-tales of degree of sparking at moment of contact

strument since it incorporates the tube tester principle with the multimeter. At any rate, it should supplement the tube tester and multimeter rather than replace it. The analyzer or set tester might be more convenient to carry to a job, whereas the multimeter and tube tester would be handier at a shop bench.

A cathode ray oscillograph offers an endless number of service possibilities. It may be used to check distortion, voltage gain a.v.c., as well as permit accurate alignment of r.f. and i.f. stages. With the complexity of circuits growing year by year, the demand for such an instrument has become increasingly greater. A few operations of the oscillograph are shown in Fig. 1.

Synonymous with oscillograph is frequency modulator and r.f.—i.f. alignment. Some oscillographs and signal generators have built-in frequency modulators. The choice of a separate or built-in type will vary with different individuals. Fig. 1 also illustrates the connections of a signal generator, frequency modulator and oscillograph for alignment purposes.

As business increases, you'll find that condenser replacement is an important division of servicing. It often becomes necessary to measure condenser leakage and capacity when replacing critical values. If a condenser tester is not incorporated in the set tester, or if you desire greater ranges than those available, a separate unit would be desirable.

Most trouble in auto radios centers around vibrators. Although some men won't touch auto sets, others make a specialty of it. For such a specialist, a vibrator tester is indispensable. It is also possible to test vibrators accurately on an oscillograph; the waveform of a good vibrator is shown in Fig. 2. Usually, however, when a large amount of this business is

handled, the vibrator tester is quicker.

Although most signal generators are built with a 400–500 cycle modulator for generating a tone signal, an audio oscillator will often be found desirable for making overall frequency runs on a set. This is merely plugged into the signal generator's external modulation jack and varied from one end of the scale to the other while checking with an output meter.

Fast becoming popular as a service tool is the vacuum tube voltmeter. This instrument is esteemed among the better servicemen since it permits actual measurements of r.f. volt-

the Mass Production Shop. Such an establishment serves dealers and jobbers and is not usually interested in transient trade. The by-word of such a shop is speed; therefore it is desirable that a grouped instrument layout be used for each man. Incidentally several complete test benches are available commercially; these would be ideal not only for speed shops but smaller establishments as well.

The Super Service Shop is the last division, catering to the public, serviceman, dealer and the like, on ultra-fine service work and consultation. His equipment should be the latest and

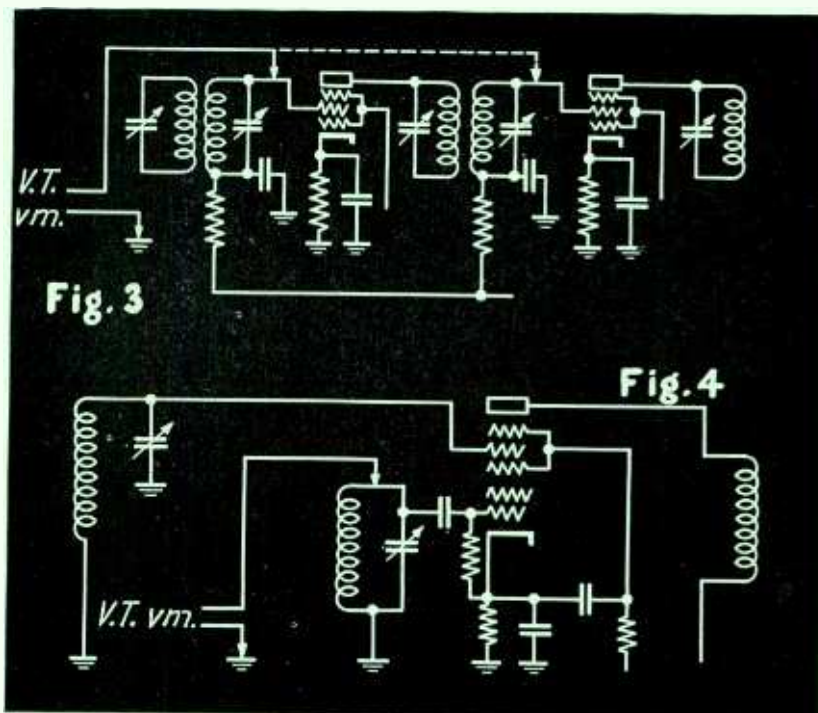

Fig. 3—SENSITIVE D.C. CIRCUITS—Vacuum tube voltmeter connection direct to grid of a.v.c. controlled tube is a positive testing method

Fig. 4—R.F. MEASUREMENT—Action of mixer tubes is critical with respect to imposed oscillator voltage. Vacuum tube voltmeter permits accurate adjustment of such circuits

ages, and in addition, "no-current" readings in sensitive d.c. circuits such as a.v.c. Illustrations of these are shown in Figs 3 and 4. A new instrument, operating on the vacuum tube voltmeter principle, has recently entered the service field. Fundamentally it consists of several VTVM in one case. With this instrument it is possible to check a number of circuits from the antenna to speaker simultaneously, thus affording a speed up method for localizing trouble.

Special Service Shops

Outside of the individual serviceman and the typical service store, there are two other classes of service. The more common of these two is

most complete. In other words, his should be a complete test lab. Impedance, capacity, and inductance bridges should be part of the equipment.

As a reminder, test equipment has, as does everything else, a definite depreciation value; some instruments more than others. The only way to keep your instruments modern and up to date is to realize the importance of this depreciation. Naturally a 1925 tube tester or analyzer would not suffice today. A good plan to enable you to stay apace with the fast moving radio industry is to deposit somewhere, a small amount weekly. Maybe it's only a few cents a week, nevertheless it will enable you to modernize when necessary.

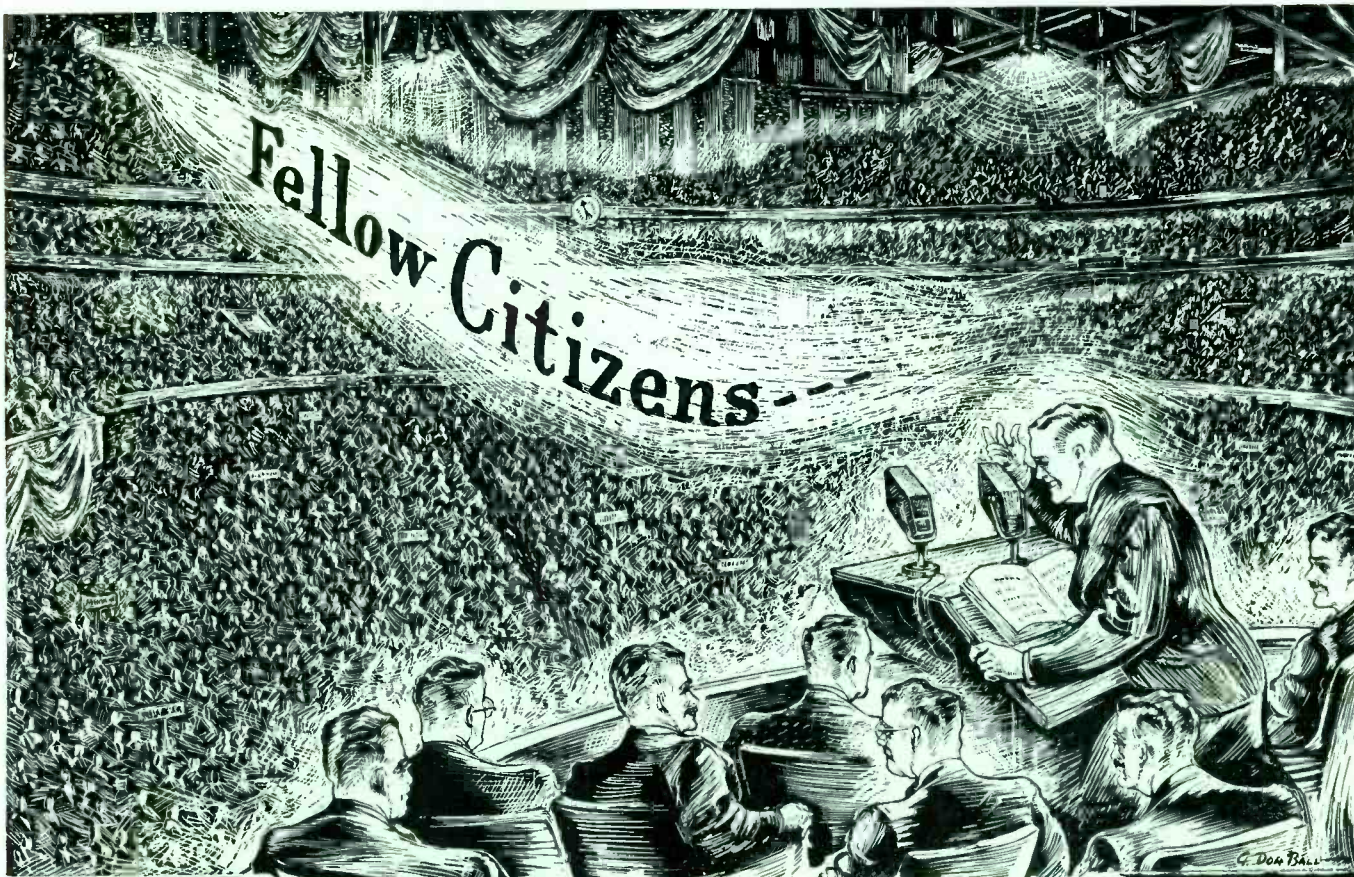

The Huge Audience Hears Every Word with *Utah* Speakers on the Job !

The vast Auditoriums and Convention Halls of this country—where large numbers of people gather to listen to inspired oratory, political or otherwise, provide a real test for any sound system speaker. At these important gatherings, it is imperative that the orator's message be carried to the most remote listener with utmost clarity and lack of distortion.

It is significant that so many of the sound systems installed in these auditoriums are equipped with Utah Speakers. They have the high fidelity and perfect tone quality, the brilliant highs and rich lows, that provide perfect reproduction of voice or music.

In addition, they offer the absolute dependability of performance that is imperative in these important sound installations and that makes every Utah Product outstanding in its field.

Ask for "UTAH" SPEAKERS—it pays.

The name
"UTAH" on any
product, means
top quality!

Utah

U T A H RADIO PRODUCTS CO.
CHICAGO, U. S. A. CABLE: UTARADIO, CHICAGO

DEPENDABLE SINCE 1922



SPEAKERS



VIBRATORS

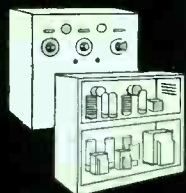

AMATEUR
TRANSMITTER KITS

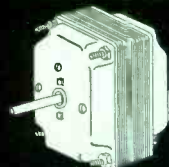

MIDGET MOTORS

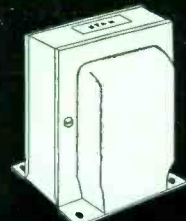

TRANSFORMERS AND
CHOKES

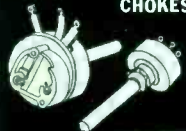

VOLUME
AND TONE CONTROLS



PLUGS AND JACKS

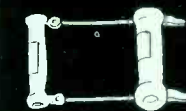

VITREOUS RESISTORS



SWITCHES

SERVICE SHOP

OLD

NEW

MONMOUTH RADIO, MONMOUTH, ORE.

Night and day improvement of typical shop. Cost was \$28.30 plus spare time of serviceman Swenson; business has noticeably increased

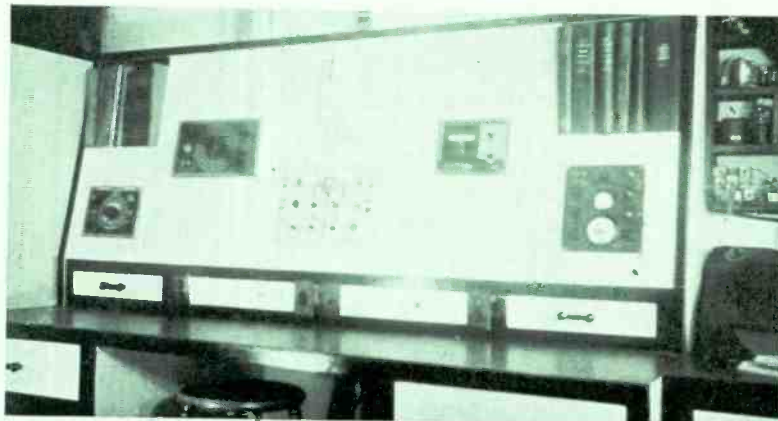
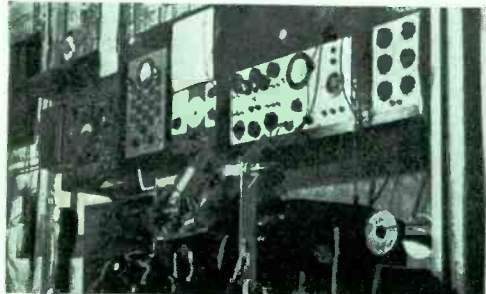

ELGREN RADIO, CLOQUET, MINN.

Morning-after appearance of old layout disappears when shining panel holds recessed instruments. All units are removable

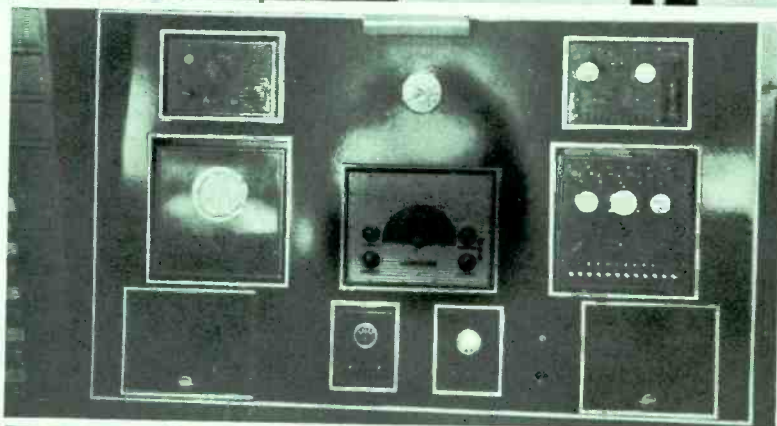

OMAHA RADIO, OMAHA

Accessibility is the keyword here, says proprietor Jenkins. Note increased drawer space and more convenient placing of tools, instruments, parts, even the junkbox

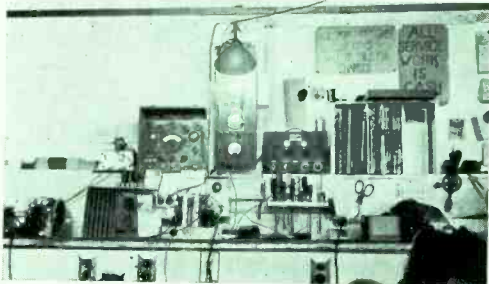

ESSENTIAL INSTRUMENTS—Bench of Adalard H. Lanoie, Northbridge, Mass., is designed for complete testing facilities with minimum equipment



SYSTEMATIC—Careful consideration has been given to placement here by T. P. Robinson, Dallas. Important instruments commonly used rate choice positions

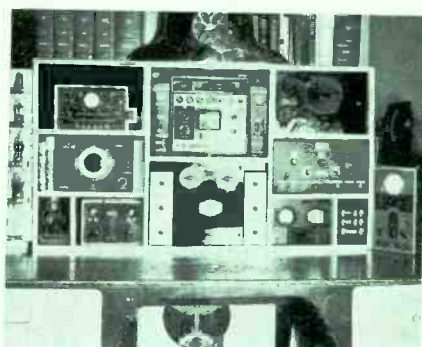

ULTRA MODERN—Use of light colored or chrome stripping and bar door handles give up-to-the-minute appearance at Fought Radio, Oshkosh, Neb.



MODERNIZATION

By
RALPH MERKLE

Hygrade Sylvania Corp.

OLD

HOWARD RADIO, AKRON, N. Y.

Specialist in test benches is Tom Howard. Although former bench is modern, new bench gives special consideration to eye-appeal and convenience of everything

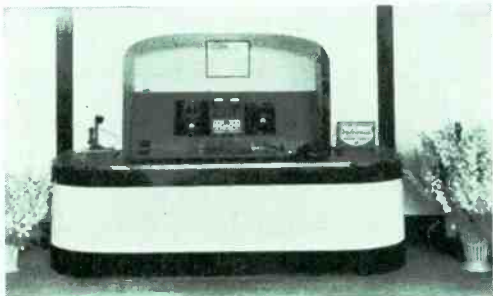

NEW



T. EARL KING, SALEM, N. J.

A real B.C. shot (before changes) of a repair shop. New bench contains all necessary instruments for quick testing

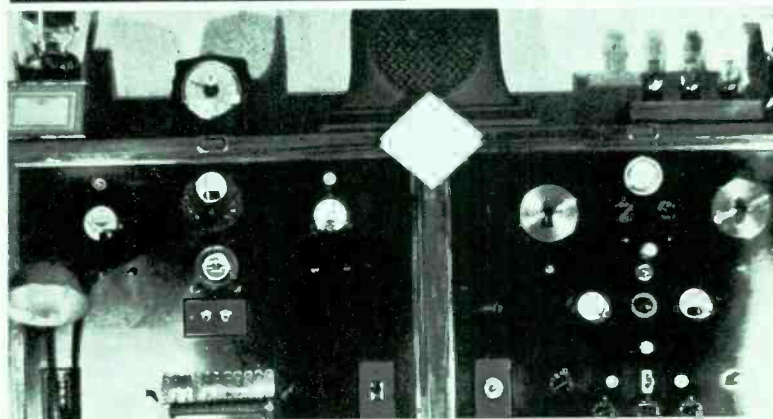

PADDOCK RADIO, WARWICK, N. Y.

Good example of modernization. Most test instruments are original equipment with better arrangements. Recessed instruments are portable

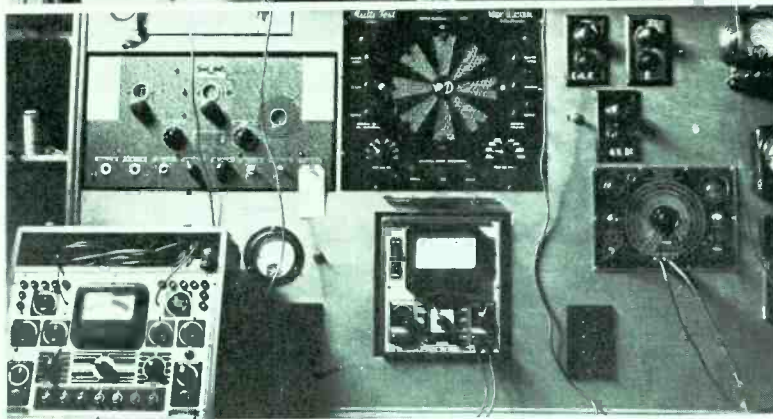

OVERHEAD SHELF—Neatly arranged bench of Don Blair, Franklin, Pa., is particularly convenient where space is at premium.

COMPLETE STOCK—Whether it means replacing a resistor or rebuilding a receiver, Zerlenga of Universal Radio, Chicago, can do the job without leaving the shop

WHATNOT TO WATT—Yessir! Chel's Radio, East Gary, Ind., is equipped to analyze any set condition, even to measuring wattage input on the watt meter at right.





Particularly if that tube tester is an R.C.P. instrument! R.C.P. instruments on your counter and work bench creates customer-confidence . . . increases the sale of other merchandise, builds your service business. R.C.P. is always the signal for bigger PROFITS! In performance the instruments speak for themselves. At R.C.P.'s surprisingly low prices, you can afford the best test equipment in radio.

Write today for full details of R.C.P.'s sensational line of test instruments. Here are two models from the complete R.C.P. line.

IMPROVED MULTITESTER MODEL 409A

New engineering features

Greater testing flexibility and many other features, all incorporated in the new model 409A at the same low price. 4 range D.C. voltmeter to 1000 v. D.C. microamps 0-500. D.C. milliamps, 0.5/0.50/0-500. D.C. ammeter 0-5. 4 range ohmmeter to 10 meg. 4 range db. meter. 4 range A.C. voltmeter to 1000 v.



Before you buy your next instrument, investigate this remarkable job. Only (as illustrated) \$19.45. Open faced model #409C—\$17.95.

COMBINATION TUBE & SET TESTER MODEL 800



A high quality instrument practically filling all requirements of modern service work. Three color multiple scales. Latest approved circuit provides comprehensive multiple tests of every type of tube. 4 range A.C. and D.C. voltmeter to 1000 v. 4 range D.C. milliammeter to 1000 ma. D.C. ammeter to 10 amps. 4 range ohmmeter to 10 meg. Decibel meter—8 + 55 db. Checks condenser leakage.

An unbeatable value at \$29.75 complete. Write for free new catalog describing the entire line of R.C.P. instruments from \$5 to \$59.

RADIO CITY Products Co.
88 PARK PLACE NEW YORK CITY



PLAN TUBE DRIVE—Forrest E. Crain, in charge of Radiotron advertising and sales promotion, L. W. Teegarden, in charge of renewal tube sales, and E. C. Hughes, assistant to Teegarden, study campaign strategy

Change Tubes Yearly

RCA plan designed to sell more complete kits tries out in Hartford

CAMDEN—Promotional plans of RCA Manufacturing Co., disclosed to *Radio Retailing* by L. W. Teegarden, Manager of RCA's Tube Sales Division, are expected to boost tube sales for every radio dealer and serviceman.

Tube sales, Teegarden contends, have been in the doldrums entirely too long. Everybody has known that a huge replacement need exists, but no dealer or distributor ever has more than scratched the surface of that market. Expert estimates indicate that, for each replacement tube that actually has been sold, obvious sales opportunities for 4 or 5 others have remained neglected. The RCA campaign which is having its dress rehearsal at Hartford, Conn., is expected to improve that situation.

Battle cry of the campaign will be the slogan "Change your radio tubes at least once a year." Radio and newspapers will pound that thought into the public consciousness. Dealers will display streamers carrying the slogan in red letters. Sales and service-men are expected to preach yearly tube changes in all their contacts.

Using the slogan as a handle, distributors and dealers have geared up their sales effort to get top effectiveness out of all promotional materials regularly supplied in connection with all three brands of RCA tubes, viz: Radiotrons, Cunningham and RCA Victor.

Pièce-de-resistance for the consumer will be the written money-back guarantee on full sets of replacement tubes, plus a trade-in allowance of 25¢ for each old tube, plus a fancy bakelite cigarette box which goes to those who buy and keep a full set of replacement tubes.

Those who have had opportunity to study the plans feel that if it's successful at Hartford it should be the starting gun for a campaign in which the whole industry could properly participate.

As pointed out by Mr. Teegarden,

campaigns to sell the public on doing this or that thing periodically have been highly successful in other industries.

For instance, the automotive industry has sold motorists of the whole nation on the idea that crankcase oil should be changed every 1,000 miles, spark plugs replaced every 10,000 miles, light grease for the gears in winter, heavy grease in summer, etc., etc. Toothpaste makers have boosted their own sales and toothbrush consumption by shouting "Brush your teeth at least twice a day" and they took the dental profession in tow—not to their sorrow—by adding "See your dentist at least twice a year."

Teegarden argues that, where these other artificially created urges tap the consumers' pocket-book much more frequently, it should not be difficult for the tube industry to sell thousands of radio fans on that modest one complete set a year tube change idea.



PACES TIMES — Cornell-Dubilier president O. Blake. Says C-D's sales increased this year despite generally lower industry pricing. Attributes gain to new product introduction, improvement of older standard items

SYLVANIA

A Synonym For "Quality"

In this magazine . . . all during 1938 . . . we have shown you examples of the extreme care and precision-workmanship that go into each Sylvania radio tube. And we've explained some of the tests and rules that help keep the famous "Sylvania quality" uniformly high.

Naturally, we have been able to present just a small portion of the entire Sylvania quality story. But we do hope one important fact has been made clear: *The name "SYLVANIA" stands for quality above all else . . . first, last and always!*

Remember this fact—let it be your guide when buying.

*Hygrade Sylvania Corp., Emporium, Pa.
Also makers of Hygrade Lamp Bulbs.*



RSA Completes First Year

Secretary's report cites accomplishments, outlines new plans for coming season

CHICAGO—From Joe Marty, Jr., Executive Secretary of the Radio Service-men of America, Inc., 304 S. Dearborn St., this city, comes the following release:

"The RSA completed the first year of its existence on October 12, 1938. A report upon its activities, progress, and future growth is in order at this time.

"In carrying out the work during the past year the original organizing board, the present Board of Directors, and the officers, have been conscious of their obligation; first, to their own members, and secondly, to the radio industry. Public acknowledgement is made of the splendid cooperation and support which has been received from the Radio Manufacturers Association, the Sales Managers Club, the Jobbers,

the Trade Journals, as well as the services and the support of innumerable personalities in the industry.

"The RSA was conceived and formed with one idea in mind; namely, to improve the welfare of the individual serviceman. With this idea in mind, numerous services have been offered by the RSA during the past year.

"The RSA has supplied to its members each month advance circuit diagrams on current radio receivers. These circuit diagrams have been supplied to the RSA through the cooperation and courtesy of interested sets manufacturers.

"A Technical Helps Bureau has been maintained in the national office whereby questions involving servicing procedure and technical facts have been extended free of charge to anyone requesting it. Such a service is, we believe, invaluable and will be continued.

"A Speakers' Bureau has been established by the national office of RSA and cooperating manufacturers, whereby speakers have been provided in a great number of cases to our local chapters. The promotion of this plan is necessarily slow since there are no precedents whereby we might be guided in our work. Speakers will be furnished as rapidly as possible to all of our chapters. We plan at least one speaker per month for each chapter.

"The national organization has pioneered an Extension Radio Service Course with the one idea in mind of providing up-to-the-minute, accurate technical information on the newer trends in circuit designs. This course is not purely a theoretical one, but a practical one whereby subscribers may be supplied with practical operating data on the new circuit ideas as soon as they are released to the general public.

"The RSA has provided a Code of Ethics and Bylaws which we proudly feel constitute a 'bill of rights' whereby the individual serviceman may come into his own as an integral part of the radio industry.

"Pocket membership cards and certificates, as well as pins and advertising cuts have been made available to all of our members. The insignia of the RSA is rapidly becoming recognized by the public as a definite guarantee of service by the individual wearing it.

"The RSA is operating at the present time fifty-two chapters in fifty-two towns and cities throughout the country. It has always been our policy, in dealing with organized local groups, to extend to them the privilege of membership as a group in the RSA without any attempt at domination or dictation. We feel that the individual local groups wherever organized, are perfectly capable of determining and putting into effect plans and policies which will result in the growth of the individual groups without interference by the national organization. The corner stone of the RSA and the basis of its strength is these individual local groups democratically controlled and operated by its own members, for the benefit of the entire body. We cannot stress too strongly the fact that the individual serviceman members of local groups, who are affiliated with the RSA, actually control the operation and policies of the national organization. The bylaws of the RSA were not written by any one man or group of men, rather they represent all of those benefits and rights which good servicemen hoped to find in old organizations in the past. One of the greatest benefits which the individual serviceman has derived from the existence of the RSA is his recognition by the radio industry by virtue of being a member of RSA. This recognition has not only been extended by one group or a few individuals, rather it is recognition concurred in by every existing group in the industry.

"In the near future the RSA will announce the starting of its Guaranteed Radio Service Plan. By means of this plan any consumer having a radio set repaired will be able to, through the national organization, receive a guarantee as to the labor and material going into the repair of such receivers. For too many years the serviceman has been held up to ridicule and contempt by the general public, and the public has been in innumerable instances badly gypped by the so-called servicemen. All good servicemen recognize these facts and by means of this guarantee plan the RSA hopes to eliminate these evils, resulting in added confidence on the part of the general public towards servicemen, as well as the increase of business for RSA members.

"Plans are underway for the promoting of better business methods and cost accounting systems for use by the individual servicemen.

"Group insurance plans whereby individual members of the RSA may receive insurance at a nominal cost are also under consideration and as soon as any plan is formulated, announcement will be made by the RSA.

"Briefly, this tells the story of the RSA to date and gives a glimpse in some small way for the immediate future. Throughout all of this article you will be able to note that our entire aim and desire is to be of service to the individual serviceman and also to cooperate with any group or individual in the industry in order that our industry may continue to grow.

"Comments and criticisms are heartily welcomed by the national office of the RSA at any time, on any phase of its program by interested individuals or organizations."

Fourteen New Stars

NEWARK—To the Arcturus constellation of tube types this month fourteen new "stars" have been added. New tube types include the 6J8G, 6K8G, 6P5G. Another midget bottle now in the line is the 6F5GT.

Triad GT's Ready

PAWTUCKET—From the Triad Manufacturing Company, Inc., comes word that the following New Bantam or GT type tubes are now ready for immediate delivery: 6A8GT, 6J7GT, 6Q7GT, 6R7GT, 25L6GT and 25Z6GT.



Thousands of Aggressive Service Engineers Make More Money by getting instruments the N.U. way

Radio owners will naturally turn to the service engineer who builds himself a reputation for having the latest things in test equipment so that he can service radios quickly and do a 100% satisfactory job.

Remember on the National Union plan you don't have to put up the amount of money which would normally be required if you were to go out and buy the modern equipment you want. Through National Union you earn the equipment through every day purchases of National Union Radio tubes and condensers.

Here's all you do:

1. Select the equipment you want.
2. Sign a National Union tube and/or condenser purchasing agreement.
3. Place a small deposit which will be refunded to you as a merchandise credit when your purchasing agreement is completed.
4. Order a small quantity of National Union tubes and/or condensers at the time you sign the agreement.
5. Apply your regular monthly purchases of tubes and condensers against the requirements of the contract.

SEE THE BIG 102-PAGE MANUAL AT YOUR JOBBER



Step Up! Equip Yourself
for More Business
the NATIONAL UNION way

WRITE FOR DETAILS
AND
NAME OF NEAREST DISTRIBUTOR

NATIONAL UNION RADIO CORPORATION
NEWARK, N. J.

RR-1138

Modernize with Triplett ...



**PUSH-BUTTON
OPERATED
TUBE TESTER**

\$39.00
in carrying
case

**MODEL
1610**

TRIPLETT

- ★ Tests All Receiving Tubes and Has Ballast Tube Continuity Test
- ★ Separate Plate Tests on Diodes and Rectifiers
- ★ Uses Approved Emission Circuit Constructed to RMA Load Requirements
- ★ Near Short Test
- ★ Illuminated Dial and BAD-GOOD Scale

This new push-button tester catches the eyes of everyone. So simple, instructions are unnecessary, even to the novice. Compact in size, and sturdily built, with all wiring in orderly cable form, it can be handled easily and safely. The new black velvet finish case with chrome fittings and the attractive colored buttons create an atmosphere of distinction and ultra-modernness whether the tester is used on the counter, in the shop or on calls in the home.

Model 1610 is Triplett precision built. GOOD-BAD illuminated meter. The approved emission type circuit is constructed to RMA load requirements and is conclusive. All types of receiving tubes including ballast tubes can be tested. push-button settings for each tube being given under each row of buttons on the perfected scroll at the bottom. Line voltage adjustment also controlled by push-buttons. Model 1610 Complete Net Price \$39.00

Model 1611 combines a push-button operated Volt-Ohm-Milliammeter with Tube Tester of Model 1610 in same type case. Uses plug-in type copper oxide rectifier. Dealer Net Price \$49.50

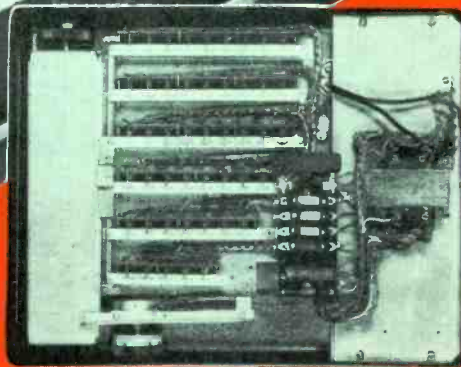

Scientifically made inside as well as out. Note the neat and sturdy construction. Built of the finest parts by experienced workmen to give lasting satisfaction. New charts in complete scroll form available from time to time at small exchange basis cost. Can be substituted in a few minutes.

THE TRIPLETT ELECTRICAL INSTRUMENT CO.
Bluffton, Ohio

The Triplett Electrical Instrument Co.
2011 Harmon Dr., Bluffton, Ohio

Please send me more information on: _____ Model
1610; _____ Model 1611.

Name _____
Address _____ State _____
City _____



GET THIS

VOLUME IX RIDER MANUAL

ON NOVEMBER 19th

ANOTHER great Rider Manual—Volume IX, covering 1938-39 American-made radio sets. Here is one of the most important volumes of them all. Every serviceman—*or none*—will need it. At your finger tips are 1650 pages of the most complete and authentic compilation of service data available in the industry. Rider Manual Vol. IX features an entirely new "How It Works" Section—the most "talked-of" feature of Vol. VIII. It makes clear by practical example the complicated circuits and baffling service problems which you must cope with in repairing modern radio sets. There is also a new 140-page index. Put this great volume to work for you right away, — place your order with your jobber without delay.

- | | |
|------------------------------------|---------------------------------|
| Vol. IX — \$10.00—Covering 1938-39 | |
| Vol. VIII—\$10.00—Covering 1937-38 | Vol. IV—\$7.50—Covering 1933-34 |
| Vol. VII — 10.00—Covering 1936-37 | Vol. III— 7.50—Covering 1932-33 |
| Vol. VI — 7.50—Covering 1935-36 | Vol. II — 7.50—Covering 1931-32 |
| Vol. V — 7.50—Covering 1934-35 | Vol. I — 7.50—Covering 1920-31 |

OTHER RIDER BOOKS

AFC SYSTEMS—144 pp. Hard Covers \$1.00
 CATHODE RAY TUBE—366 pp. 450 illus. . . . \$2.50

Other Rider Books: Servicing Superheterodynes; Aligning Philco Receivers—\$1.00 each. "Hour a Day with Rider" books on AVC Control; on Resonance & Alignment; on A-C Distribution in Radio Receivers; on D-C Distribution—60c for each book.

JOHN F. RIDER, Publisher
 404 Fourth Ave.,
 New York City



With the JOBBERS and REPS

RADIO CITY—Radio City Products Company, maker of tube testing equipment of Richmond, Virginia, to represent, has appointed George W. Hurdent the line in Virginia, North Carolina and South Carolina, Stuart D. Clayton and George H. Cameron have also been appointed field representatives, will cover Indiana, Wisconsin and southern Illinois, Ohio and Kentucky, out of Chicago and Cleveland offices respectively.

STANCOR—*W. Bert Knight, Inc.*, of Los Angeles now covers the lower part of California up to and including Fresno; Arizona; Nevada and Utah for the Standard Transformer Corporation. The *Brown-Sherrill Company* of Charlotte, N. C., will cover North and South Carolinas, Georgia with Stancor's fan line only. *Hollingsworth & Stiel*, of Atlanta, has Alabama, Georgia, Florida, North and South Carolina and Tennessee. *J. M. Cartwright* of Memphis will cover Louisiana, Mississippi, Memphis and Jackson in Tennessee, Texas and Eldorado in Texas.

P-L—Representative covering Ohio and the city of Erie, Pennsylvania, is *Arthur H. Baier*, working out of Cleveland. *Samuel K. Macdonald* has just been appointed rep in Philadelphia, will cover Pennsylvania with the exception of the city of Erie, the states of West Virginia, Virginia, Maryland, Delaware, the District of Columbia and eight counties of New Jersey.

KENYON—*E. P. Demarest* of the Sylvania Pacific Company, 1127 Venice Blvd., Los Angeles, now has the entire state of California on this transformer line. *George D. Norris* of 307 Wall, Seattle, will cover Washington, Oregon, Montana, Idaho and Southern British Columbia.

STROMBERG - CARLSON — *Motor Parts Company*, headquarters at 17th and Indiana, Philadelphia, has this line for eastern and southeastern Pennsylvania. Stuart F. Louchheim and Carl Wilkening are execs., have Leonard refrigerators, Tappan ranges, Bendix washers under their wing too.

Ebenholtz Leaves Ariston

CHICAGO—On November 1 Paul H. Tartak acquired the stock originally held by Harold Ebenholtz in the Ariston Manufacturing Corporation and the Ariston Laboratory, Inc. Ebenholtz has withdrawn from the organization due to ill health.

Mr. Tartak has been elected president of both companies and Walter Bauman becomes vice-president in charge of sales. Tartak retains his presidency of the Oxford-Tartak Radio Corporation.

JIM QUAM Says

Maybe you've seen the chest that stands in my office. It's made of wood, with hand-wrought iron hinges, curiously shaped handles and corner braces, and, although badly scarred, it's still as staunch and strong as the day it was built. When the craftsman laid aside his plane and chisel, he painted it a bright blue, decorated it with colored flowers, and then, proudly, boldly, he painted on the date—1729.

That man was proud of his job and rightfully so, for today, two centuries later, that chest is still in daily use.

We do things differently today,—but I'll tell you this—I'm just as proud—and our people are just as proud—of every Quam Speaker that comes off the lines as that man who built the chest 200 years ago.

QUAM-NICHOLS CO.
 33rd Place & Cottage Grove 1674 Broadway
 CHICAGO NEW YORK

QUAM SPEAKERS

The AMPERITE ACOUSTIC COMPENSATOR

gives you **HIGH OR LOW PITCH**

WITH THE SAME MICROPHONE

With the flip of a finger you can now (1) lower or raise the response of the microphone. . . (2) adjust the microphone for most desirable response for close talking or distant pickup. . . (3) adjust the system to any "taste", room condition, or equipment.

MODELS RBHk, RBMk, with Acoustic Compensator, frequency range 40 to 11000 cps, output, -65 db., complete with switch, cable connector and 25' of cable. \$42.00 LIST

NEW! MODEL RSHk (hi-imp); RBSk (200 ohms) Frequency range 60 to 8000 C.P.S. Output -68db. \$32.00 LIST

NEW LOW PRICE CONTACT "MIKE"
 Model SKH (hi-imp); SKL (200 ohms) \$12.00 LIST

MODELS RAH-RAL, excellent for speech and music. Reduce feedback. \$22.00 LIST

Write for Complete Illustrated Bulletins and Valuable Sales Helps.

AMPERITE Co. 561 BROADWAY, N. Y.
 Cable Address: Alkem, New York

AMPERITE Velocity MICROPHONE

"Now IT CAN BE TOLD."

THERE are times when it is difficult to make people believe the simple truth! When Simpson Instruments were first announced in August, 1936, the simple truth was that they were predestined, by the very circumstances of their conception, to tower above all other radio testing equipment.

Their background assured this. They had behind them the vast experience of Ray Simpson and a group of associates who had devoted their entire engineering careers to instruments and test equipment. They had behind them an unstoppable "will to win" born of a fresh start—in designing, tooling, and production methods. With such a background, success was inevitable.

Yes, we could have forecast that success in 1936—but we could not have told the story with the force it has since been told by the product itself! Look at the record of those two and a half crowded years. Measure Simpson Instruments by any standard—design, workmanship, range, performance, beauty and, above all, sheer quality in solid terms of dollar-value. Try to find a Simpson Instrument that has failed to do its job—better. Try to find a model that has not been a complete success. Of what other line can this be so truthfully said?

Now it can be told that Simpson alone can give you an instrument covering every conceivable need—each built to that exalted standard which can only be described as Simpson. A few models are briefly described here. Coupon brings details.

SIMPSON ELECTRIC CO. 5204 Kinzie St., Chicago, Ill.

MODEL 230 — The smallest A.C.—D.C. instrument on the market yet it contains a sufficient number of ranges for the experienced man to do a complete servicing job. Price..... **\$14.25**



MODEL 215 — The first small instrument to have a big 4½-inch meter with easy - reading dial. Five A. C. and D. C. voltage ranges—five Decibel ranges — 0-10 - 100 - 500 milliamps; 0-250 microamps; 0-4000-400,000 ohms; 0.4 megohms. Price... **\$25.75**



MODEL 440 "TEST MASTER". An all-service tube tester and set servicer—for general servicing, auto radio servicing, public address, sound equipment, etc. Double-filament switching; screen fluorescence and angle test, hot cathode leakage test, "high sensitivity" neon short check, noise test, percentage scales, "good" and "bad" scales. As set tester has six A. C. and D. C. voltage ranges; resistance ranges from 1 ohm to 100 megohms; four milliamp ranges; six decibel ranges; 0-15 ampere scale for auto radio work; meter leakage test, etc. Everything you can possibly need in a tube and set tester. Price. **\$59.00**



MODEL 333 TUBE TESTER—Small (only 7½" x 10½" x 5") Light in weight—only 7 lbs. . . . at a price to fit any pocketbook. Tests anything from Christmas tree lights to gaseous rectifiers. Double filament switching—double everything—at the remarkable price of **\$26.50**

- ANY SERVICE RANGE — ONE SIMPSON QUALITY**
- MODEL 220** Tube and Set Tester with famous "Roto-Ranger" feature \$62.75
 - MODEL 250** Set Tester with 20,000 ohms per volt. \$42.50
 - MODEL 275** Set Tester with 10,000 ohms per volt and "Roto-Ranger" scales. \$42.50
 - MODEL 202** D. C. — A. C. Volt - Ohm - Milliammeter with "Roto - Ranger" \$35.75
 - MODEL 201** D. C. Volt-Ohm-Milliammeter with "Roto-Ranger" \$32.50
 - MODEL 205** D. C. Volt-Ohm-Milliammeter \$13.25
 - MODEL 210** Line operated Signal Generator \$49.00
 - MODEL 211** Battery Type Signal Generator \$39.50

MAIL THIS COUPON

Simpson Electric Co.
5204 Kinzie St., Chicago, Ill.
Please send facts about models

Name.....
Address.....

SIMPSON

INSTRUMENTS THAT STAY ACCURATE

FIRST AID FOR FLOOR MEN

(Continued from page 47)

set in his home.

He will believe these stories—if we haven't "committed" ourselves. And don't think for a minute that we committed ourselves when we asked how much he was figuring on paying down. Oh, no! Why we only asked that so we could give him the *exact* figures on the monthly payments. "As a matter of fact, Mr. Doodle (if he balked) I'd much prefer that you try this set first, even if you *were* ready to buy it right now. We know, from experience, that if a set is not satisfactory we are going to get it back, or make an enemy. And for that reason we like to make sure the set is satisfactory first. Something else, you don't know just how well your wife will like this set. I tell you what I'll do. . . ." And then we sell the demonstration.

I am not saying that we should try to sell demonstrations and not radios in the store. I *am* saying that we should not commit ourselves, not burn our bridges behind us, by *obviously* trying to sell—thus rendering the demonstration sug-

gestion worthless.

(6) A demonstration sold to a "walk-in" is *worth* making. It is usually a sure sale. It is so valuable, in fact, that we should do nothing to spoil our chances of getting it. And we must never lose sight of the fact that our prospect can walk out on us whenever he wishes, and that if he does—he is *lost*. He's liable to walk right around the corner and buy a set. He *won't* do that if we sell him a demonstration.

On the outside we know where to find our prospects, and we can contact them as often as we see fit. But when a prospect walks out on us in the store, that's the last we'll ever see of him. Unless. . .

As A Last Resort

(5) . . . we have his name and address. We want this, if we can get it, so that we, or an outside man, can make the contact in the event we fail to sell or arrange for a demonstration. And provided, of

course, that the man really had some legitimate reason for neither buying nor accepting a trial immediately.

(3) When we start showing the gentleman our sets, we have no preference for any particular model, but as soon as we find out which model appeals to *him*, that is the one we like best too. They're all good sets, of course, but, strangely enough, he has happened to pick out the very model that we ourselves think is just about the best buy in the place, everything considered. Fundamental reason? Because it's easier to sell him the model he likes than it is to sell him any other model.

So there he is. *You* wait on him. You've got to either sell him a set without pressure and without committing yourself, arrange for a demonstration, or get his name and address.

But whatever you do, please don't *lose* him. Because he is a good prospect. He's going to buy a radio. Otherwise he wouldn't have walked into your store in the first place.

WHAT ENGINEERS LIKE ABOUT CINAUDAGRAPH SPEAKERS

What engineers like about Cinaudagraph Speakers is the even, high quality of tone and dependability of construction. Furthermore Cinaudagraph offers this fine quality in a complete line of permanent magnet and electro-dynamic speakers from 5" to 18". Investigate the new profit possibilities of comparatively priced Cinaudagraph speakers used so extensively by the country's foremost manufacturers of radio and Public Address equipment.

Write to Cinaudagraph Corp.,
Stamford, Conn., for new
descriptive catalog today.



CINAUDAGRAPH CORPORATION
STAMFORD, CONNECTICUT

CARBON FIXED RESISTORS



CONSOLIDATED Fixed Carbon Resistors are the result of years of research and experimentation to produce a resistor of suitable operating characteristics for the radio trade. They are of solid molded construction, permanently bonded into one compact unit. Resistance variation is maintained at a 5% average — and is guaranteed within 10% plus or minus. They are quiet in operation — completely moisture-proof and non-inductive, having no capacity effect — and maintain their resistance values over an extremely wide temperature range.

Packed in attractive three-color cartons and sold only through recognized parts jobbers.

See Them At Your Parts Jobber's Today!

CONSOLIDATED
WIRE AND
ASSOCIATED
CORPORATIONS

512 S. PEORIA ST. CHICAGO, ILLINOIS

For the FIRST TIME in the Industry

Completely Standardized

P.R. MALLORY & CO., Inc.
MALLORY Fabricated Plate*

***FP CONDENSERS**

New, Compact Trouble-Free Units Having Exceptional Range of Application



Specified for original equipment by leading radio manufacturers, new Mallory FP Condensers are now available to radio service engineers, amateurs and experimenters. They are ideal for construction purposes and for all service applications where the special characteristics of these new condensers are of vital importance.

Two years of research and intensive development by Mallory engineers have gone into the final perfection of these revolutionary Fabricated Plate Condensers. A minimum ratio of 10 to 1 accomplished without acid etching provides extremely small sizes without squeezing, or sacrificing any of their excellent electrical characteristics.

Again Mallory provides revolutionary features.

1. Small size without a sacrifice of safety or efficiency.
2. Low R. F. Impedance. Quieter operation of vibrator powered sets.
3. Long life due to chemical purity and freedom from corrosion.
4. Surge proof construction obtained through new separator materials.
5. Better filtering efficiency.
6. Permanent identification of condenser ratings.
7. Improved performance for battery sets with minimized battery drain.
8. Improved sealing against unusual humidity or heat.



TYPE BB

P.R. MALLORY & CO., Inc.
MALLORY

Fabricated Plate Tubular Condensers

New Mallory Type BB Condensers, with exclusive Fabricated Plate construction offer in a "tubular" all the typical advantages of the Mallory FP Condenser. Made with a one piece drawn aluminum can and covered with heavy, deeply embossed cardboard tube for rating identification. Equipped with heavy leads . . . no thin foil tabs.

YOUR DISTRIBUTOR HAS COMPLETE INFORMATION ON THESE TWO AMAZING NEW CONDENSERS. SEE HIM TODAY.

Use

P.R. MALLORY & CO., Inc.
MALLORY
 REPLACEMENT
 CONDENSERS...VIBRATORS

P. R. MALLORY & CO., Inc.
 INDIANAPOLIS INDIANA
 CABLE ADDRESS—PELM.ALLO

Use

YAXLEY
 REPLACEMENT
 VOLUME CONTROLS



at Zenith

**ONLY THE "IMPOSSIBLE" TOUGH ONES
ARE RETURNED
FOR A SUPREME CHECK-UP**

"It's here where we bring the tough ones," says Frank E. Smolek, Service Engineer, Zenith Radio Corporation. "After every effort has failed in the field these 'impossible' sets are returned to us for a complete check-up with SUPREME instruments. We have used SUPREME instruments in our factory service department for years—that is why we unqualifiedly recommend SUPREME instruments to jobbers, dealers, and servicemen."

Many familiar SUPREME instruments are illustrated in the above photograph of the Zenith Service Department. In the foreground, at right, is a new SUPREME LAB-RACK arrangement, consisting of the Model 571 Oscillator, 592 Set Tester and 596 Substitution Box. Individual models, combination portables, or many rack arrangements make SUPREME instruments your logical choice.

**Features of NEW MODEL 571
SIGNAL GENERATOR**

(Illustrated Above)

Fundamentals 65 K.C. to 20.5 M.C. . . . Five bands read on only two scales . . . Reads like a meter scale . . . Unlimited range on harmonics . . . Illuminated dial . . . Shadow tuning . . . Dual ratio knob . . . Variable iron core coils . . . Air dielectric trimmers . . . Two percentage levels of amplitude modulation 30% and 75% . . . Sine wave demodulated wave form . . . Frequency 400 cycle note unchanged when percentage modulation changed from "high" to "low" . . . replaces multivibrator . . . 400 cycle wave used externally or can be modulated externally . . . High output 0.1 volt all bands . . . Full instructions . . . Step by step receiver alignment procedure . . . Write today for new literature . . . Get the amazing story of an amazing new instrument . . .

Write for New Literature
See Your Part Jobber Today

SUPREME

SUPREME INSTRUMENTS CORP. GREENWOOD MISS., U. S. A.

EXPORT DEPT., ASSOCIATED EXPORTERS CO., 145 W. 45th STREET, NEW YORK, N. Y., CABLE ADDRESS: LOPREN, N. Y.

ask yourself

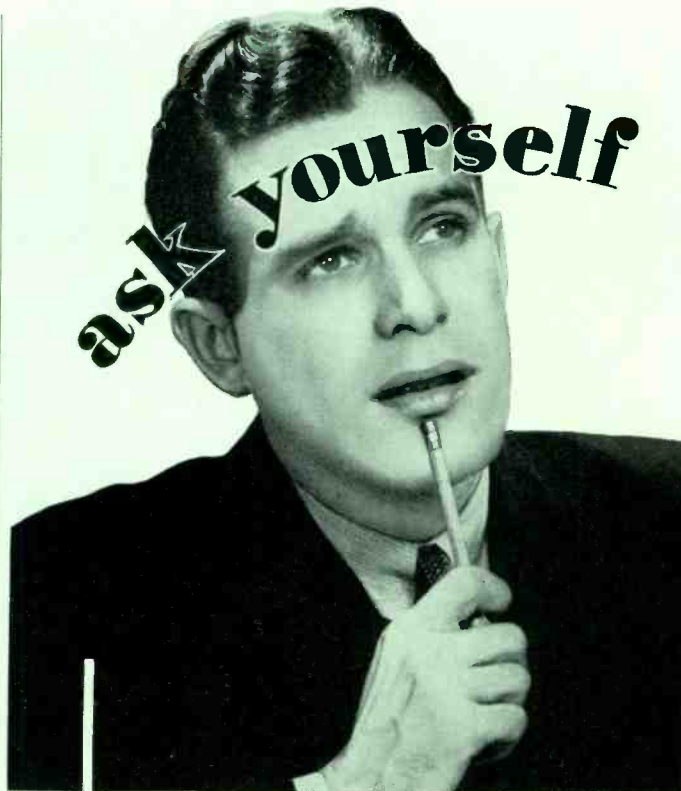

Is mine a representative service business?

Is my location free from interference with already established Tung-Sol agents?

Can I match my competition in technical knowledge and service equipment?

Can I turn over my tube stock at least every three or four months?

Are my facilities adequate to make use of attractive displays?

Have I a reputation for maintaining standard prices?

Can I be depended on to make monthly reports of consigned stock with remittance for tubes already sold?

Dealers who can answer "yes" qualify under the Tung-Sol Consignment Plan. This means an adequate supply of world famous Tung-Sol Tubes without investment. If you think you qualify, write for details.

TUNG-SOL
Radio Tubes

TUNG-SOL LAMP WORKS, Inc. • Dept. B • Radio Tube Division
SALES OFFICES: ATLANTA • CHICAGO • DALLAS • DENVER • DETROIT
KANSAS CITY • LOS ANGELES • NEW YORK • GENERAL OFFICES, NEWARK, N.J.

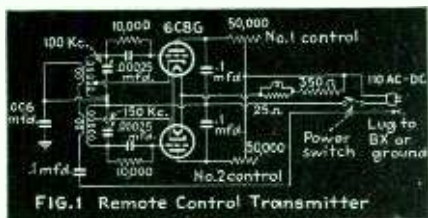

Wireless Gain Control

The present trend of radio and other electronic appliances is toward convenience of operation. Controlling gain of a sound installation from a distance without wires is a novel and useful slant on the subject of wireless control. Such is the new system by Bogen.

Referring to Fig. 1, the transmitter, oscillation of each section of a 6C8G takes place at 100 and 150 kc. respectively. The frequency is determined by the tuned coil in each grid and cathode circuit. The plates are grounded with respect to r.f. Since the plate of each section is not at high r.f. potential with respect to the oscillatory circuit, plate voltage may be varied by a simple series resistance in the B plus lead. These are shown as Control #1 and #2 and serve to increase or decrease the amplitude of oscillation, consequently the output of each oscillator. Output is inductively fed between the power line and bx shielding. The line and shield then serve to conduct this energy to the receiver located at the amplifier.

Plate voltage for the transmitter is unrectified a.c. from the line; filament voltage is obtained through a line cord resistor.

The receiver (Fig. 2) consists of two tuned circuits identical to the transmitter, inductively coupled to the power line. These feed the diode plates of two 6B8 detectors. R.F. voltage applied from the line is rectified, serving as bias to the pentode sections of each tube. Without a rectified signal, bias on each tube is low. Consequently plate current is at a high value. Before going further it must be mentioned that the plate circuit of each 6B8 tube is connected through a 2 ft. cable and plugged to the control circuit of the amplifier to be described later.

As the output of each transmitter is increased by decreasing the resist-

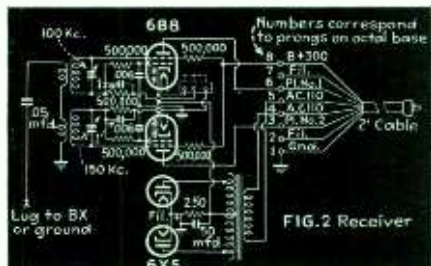

ance value of control #1 or #2, the voltage rectified by each diode in the receiver increases. Since this voltage couples to the grid of the pentode d.c. amplifiers, the bias increases and plate current increases.

Turning to the control circuit shown in Fig. 3, the receiver connects to this circuit through the octal plug shown at the lower left. Leads from pins #3 and #6 are from the plates of the 6B8s in the receiver. These connect to B plus through 500,000 ohm resistors. Also connected to the same resistors is the plate circuits of the 6J7 control tubes. Any change in plate current of the 6B8 pentodes in

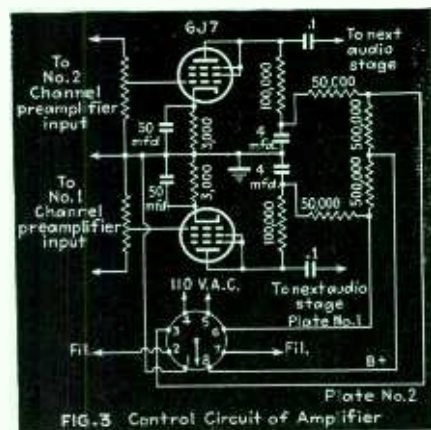

the receiver will cause a corresponding voltage drop through the 500,000 ohm resistors. This at the same time drops the voltage to the 6J7 control amplifiers. Thus, without a signal from the transmitter, the plate current on the 6B8 tubes is high, likewise the voltage drop in their plate circuit is high and the plate voltage on the 6J7s low. The amplifier is then inoperative. With the transmitter operating, the received signal biases the 6B8s, reducing plate current and voltage drop in their plate circuit. Consequently, higher voltage is applied to the 6J7 control tubes and higher amplification achieved.

Regenerative Detector

Sometimes midget receivers work well in some locations and poor in others. Providing the antenna is long enough, poor operation can usually be traced to conditions such as a resonant or anti resonant antenna or ground system which loads down the circuits and prevents a normal amount of regeneration. We all remember the old blooper receivers which were most sensitive when operated right on the point of spilling into oscillation. Such hairline regeneration is not

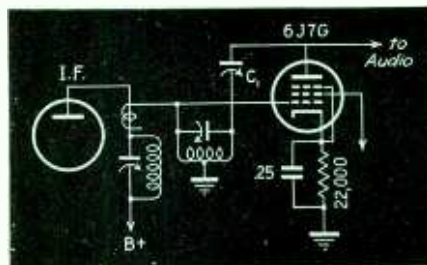

necessary today however, a certain amount of regeneration is desirable in small sets since the number of tubes is limited and maximum gain per stage is essential.

The detector circuit shown herewith is from Stewart-Warner's 97-96-S chassis. Actually it is a balanced circuit common in neutralized amplifiers. The neutralizing condenser C_1 could be made to provide negative regeneration (degeneration) and balance out normal feedback in the tube. On the other hand it also could be as a regeneration control by setting it at either side of the balance point.

For the correct operation of this control the set should first be placed in operation and the antenna connected. Adjust C_1 while listening to a weak station until the volume begins to increase. By continuing further in the same direction a point will be reached where the set begins to squeal. Then turn the C_1 back just far enough so the squeal disappears and tone quality is best.

Stage Gain Measurements

For some time the question of testing receivers by measuring the overall gain and comparing it to factory measurements has been the dream of many servicemen. This would be an ideal method except for the fact that factory measurements were not available. The service sheets of Motorolas new models now contain this data.

Measurement is made by feeding a calibrated signal generator into the antenna the mixer grid or first i.f. grid. The microvolt output of the generator is then advanced so as to give a predetermined reading on standard output meter connected across the voice coil.

All stage gain tests are made with the volume control set for full volume. The shielded lead from the signal generator connects to the top grid terminal of the stage under test through a .1 mfd. condenser with a 500,000 ohm resistor connected as a leak resistance between the grid of the tube and the grid cap which has been removed.

Only



TYPE CS VOLUME CONTROLS

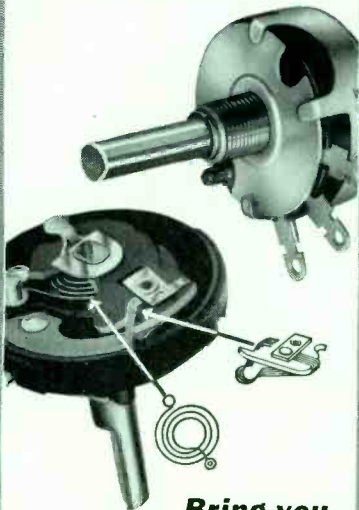

Bring you
**RADIO'S MOST
EFFECTIVE NOISE
ELIMINATING
FEATURES**

- 1 Silent Spiral Connector
- 2 5-Finger Knee Action Silent Element Contactor

... each equally important, each pioneered and perfected by IRC. The combination of these two features plus the outstanding dependability of the famous IRC Metallized type element insures better performance under all conditions than any other known construction.

**INTERNATIONAL
RESISTANCE COMPANY**
401 N. BROAD ST., PHILADELPHIA

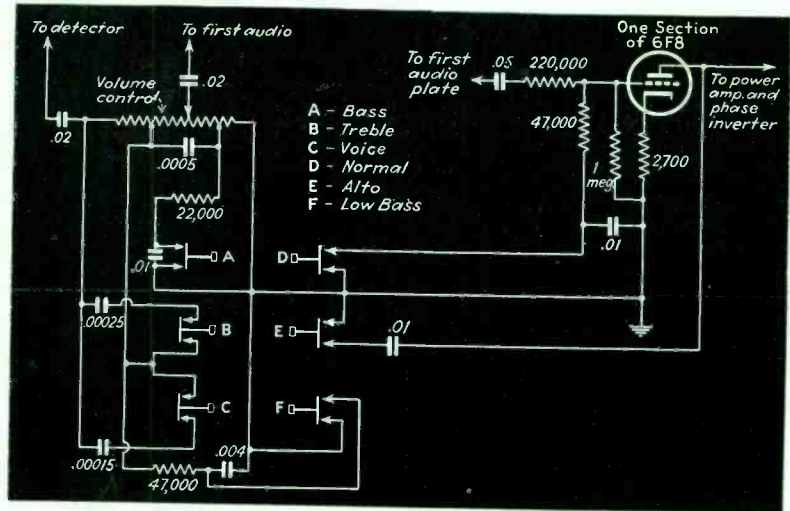

Radiorgan

Essentially, the Radiorgan in the new Zeniths is a tone control system permitting various stages of high and low boost in the audio circuit. This is accomplished by a six button push-button switch which inserts or removes various networks from the circuit. The action is similar to stops used on an organ.

Examining the circuit will show that button "A" introduces a capacity from the low tap on the volume control to cathode, by passing highs, providing what is called a "high cut." Button "B" and "C" introduce a high boost into the grid circuit of the first amplifier by adding capacity from a high point on the volume control to a 100,000 ohm tap on the control. Keys "D" and "E" provide high cuts on the second audio amplifier which is one section of a 6F8. The other triode of the 6F8 serves as phase inverter.

The buttons, or stops as they are

more correctly called, are labeled as to the response offered by each. With all combinations of these 6 buttons a total of 64 tone positions are available.

Single-Ended Tubes

The announcement of the new single-ended 6SJ7, 6SK7, 6SF5 and 6SQ7 by RCA is undoubtedly a major stride in tube design and is destined to bring even further changes in set construction. These tubes are electrically similar to types without the "S" prefix.

A single-ended tube is one in which all electrodes, including the control grid, terminate at base pins. Single-ended tube types are easily adapted to chassis construction, because leads connecting to socket terminals may be short and rigid. Furthermore, the elimination of a flexible lead and top-

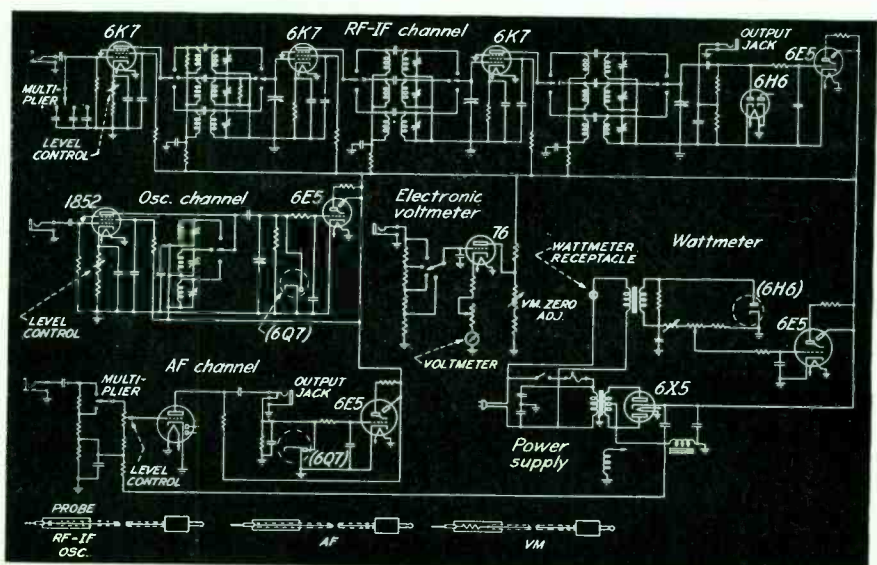

Schematic of the Chanalyst by Service Instruments as described in block diagram in the July issue. Since this drawing was made pin jacks have been added to the electronic voltmeter so that the voltmeter may be used as well as the indicator tubes to show signal level.

Centralized SOUND FOR SCHOOLS

• Here is a golden opportunity for Dealers and Servicemen. The Bogen Junior is expressly designed to enable schools, hotels, institutions, Department Stores, etc., to have the combined facilities of an intercommunication system and allwave radio tuner plus provision for a phonograph input all in one deluxe unit. Here are some of its desirable features.

- Provision for Remote Control
- Visual Volume Indicator
- Talk-Back-Operation
- Selective or group calling
- Master emergency switch
- Frequency equalizer for tone
- Expansion Capacity up to 32 rooms



Model S-32

These units are furnished with a steel door and fool-proof lock not shown in illustration. Speakers housed in beautiful walnut baffles designed for tilt-angle wall mounting to assure correct acoustics. Bogen school systems have the approval of leading educational institutions throughout the country. See your Jobber at once or write direct for Descriptive Literature to Dept. R. R.

**DAVID BOGEN CO. 663 BROADWAY
INC. NEW YORK, N. Y.**

UNIDIRECTIONAL DYNAMIC D9T

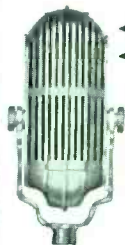

← BACK No Pickup
← FRONT Full Coverage

**VOLUME INCREASED
by Reducing Feedback**

D9T, list \$37.50 High Imp.
25' Cable

D9, list \$35.00 Low Imp.
25' Cable

Write for Catalogue No. 29

Manufacturers Full Line Dynamic, Crystal,
and Carbon Microphones and Stands

AMERICAN MICROPHONE CO., Inc.
1915 So. Western Ave., Los Angeles, Calif.



B9
Crystal
List \$22.50

D7T Dynamic
List \$22.50

A GOOD NAME GOES A LONG WAY



You can depend on Ken-Rad Radio Tubes to keep customers happy. Superior engineering assures better reception.

Ken-Rad Tube & Lamp Corp.
Owensboro, Ky.

KEN-RAD
DEPENDABLE RADIO TUBES

LEADING DISTRIBUTORS and EXPERT SERVICE MEN

*Are All Stepping
To this Popular*

SWING TUNE:

*STANCOR'S
THE LINE
FOR NINETEEN-
THIRTY-NINE!*

N.B. There's More Switching to Stancor Today Than to Any Other Line in the Transformer Field THERE MUST BE A REASON . . . !

STANCOR

STANDARD TRANSFORMER CORPORATION
1500 NORTH HALSTED STREET, CHICAGO

New SCHOOL SOUND SYSTEMS BREAKING ALL SALES Records!

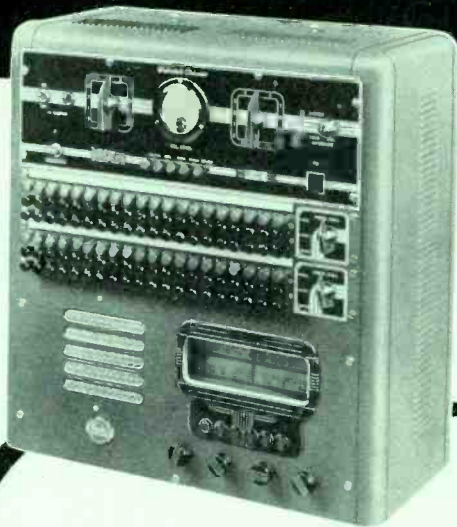

Let
Webster-Chicago
help you Cash in
on these
BIG UNIT Sales

← **Model S-40**
for any number of rooms
to 40

Model S-40 . . . a sectionalized system with two channel features completely installed in attractive metal cabinet. Highest quality custom built refinements. Can be purchased for schools of 10 rooms or less and added to as building or budget requirements necessitate. Maximum capacity—40 rooms.

2 SYSTEMS SECTIONALIZED ANSWER ALL REQUIREMENTS

Model RP-100 →
for unlimited number of rooms

Model RP-100 . . . a custom built system having a basic flexible design permitting such personal selection as:

- Any Number of Rooms
- Multiple Channel Service
- Any Number of Program Originating Points
- Automatic Record-changing Equipment
- Tone Equalization for Unusual Acoustical Conditions

Are you going to share in the profits of school installations? Don't let the fact that they run into big figures stop you. As designed by Webster-Chicago, installation of either system is relatively very simple and satisfactory performance is assured from our 15 years' experience.

Beautiful 2-color literature available for mail work or direct solicitation. Ask your jobber or write for more information.

**COMPLETE SPECIFICATIONS
AVAILABLE FOR MAILING TO
SCHOOL ARCHITECTS**

RR-1138

WEBSTER-CHICAGO

5622 Bloomingdale Ave., Chicago, Illinois

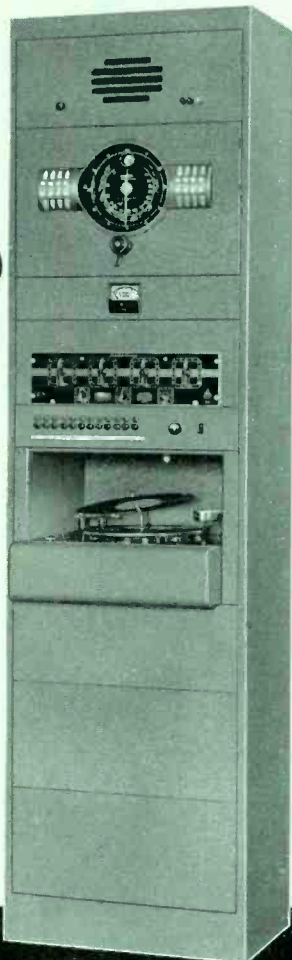

Manufactured under license
arrangements with Electrical
Research Products, Inc., sub-
sidiary of Western Electric
Co., Inc., and American
Telephone and Telegraph Co.

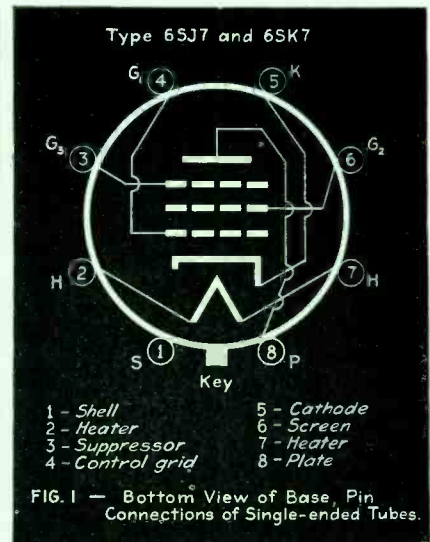

cap connector may effect an appreciable saving in cost.

When the control grid and plate of an r-f pentode terminate at base pins, these pins should be arranged for minimum plate-grid capacitance. Obviously, when all the base pins are placed around the circumference of a circle, minimum plate-grid capacitance is obtained when plate and control-grid pins are diametrically opposite. With such an arrangement of plate and control-grid pins, as shown in Fig. 1, plate-grid capacitance may be reduced further by proper shielding.

The sketch of Fig. 2 shows the manner in which this shielding is accomplished in the types 6SJ7 and 6SK7. A cone of metal is inserted through the hole in the stem to which the exhaust tube connects; the cone extends some distance into the exhaust tube and connects to the shell of the tube. Another shield, cylindrical in shape, is inserted inside the locating base plug between the exhaust tube and the base plug; this shield also connects to the shell of the tube. The purpose of the conical shield is to reduce capacitance between leads in the glass of the stem; the purpose of the cylindrical shield is to reduce capacitance between those pins that are diametrically opposite.

The socket in which the tube is inserted contributes to interelectrode capacitances. Capacitance measurements on a number of different types of sockets indicate that the capacitance between diametrically opposite socket terminals may have values between 0.005 uuf and 0.01 uuf; however, when the shielded locating base plug of the 6SJ7 and 6SK7 is inserted, these capacitance values decrease to approximately 0.0001 uuf and 0.003 uuf, respectively. The wafer type of socket ordinarily employed in radio receivers introduces very little capacitance and is entirely satisfactory for most applications. A further reduction in these capacitance values can be obtained by placing the screen by-

pass condenser close to the base pins. Because one terminal of this condenser is grounded, it acts as a shield when it is in close proximity to the base pins. Placing high-potential leads close to the chassis also assists in reducing the effects of capacitance coupling between leads.

It is noted from Fig. 1 that the basing of the 6SJ7 and 6SK7 is such that the control-grid pin is shielded from the heater pin by the suppressor pin, which normally is at ground potential. This arrangement minimizes the magnitude of hum voltage on the grid due to capacitance coupling between grid and heater.

The advantages of having short, rigid grid leads are easily demonstrable in high-gain receivers. For example, in one receiver employing top-cap tubes, capacitance coupling between grid lead of an r-f amplifier and the grid lead of the converter tube was sufficient to introduce an appreciable amount of regeneration. This condition served a useful purpose in that the regeneration increased the sensitivity of the receiver.

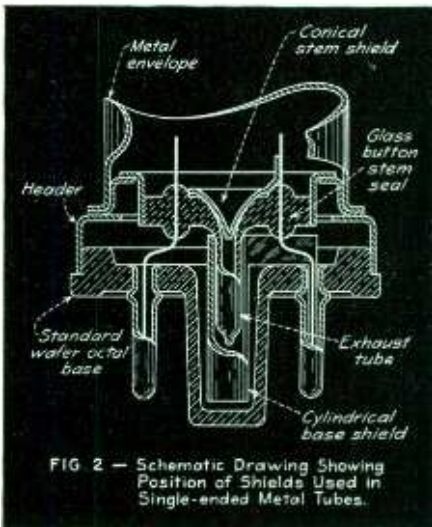

WHAT THIS BUSINESS NEEDS . . .

By Howard Siebold

WHAT THIS BUSINESS NEEDS . . .

is paper condensers that won't fail below their rated working voltage. Almost all types are spirally wound; the first turn or two is invariably folded and wrinkled, break down usually occurs at this crease. Any method which would start the winding smoothly probably would double or triple condenser life.

Radio Retailing will pay \$1 for every published "What This Business Needs". Submitted items must be technical and constructive.

Don't Take Our Word For It!

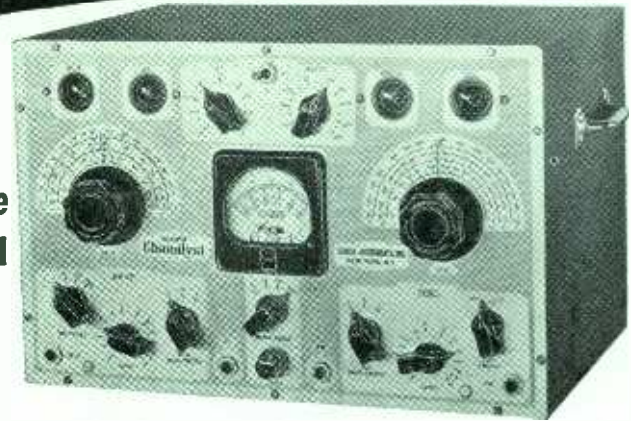

Net \$107.50

Read what these **SERVICEMEN** say about

The
RIDER Chanalyst

COATESVILLE, PA. "It's the easiest thing to use in my shop . . . does away with all guesswork and speeds up our service work. . . . I put it to work as soon as I got it and have been using it every day since, on large and small jobs."—M. Godschall.

PADUCAH, KY. "I have had better results with the Electronic Voltmeter (in the Chanalyst) than any other output indicator I have tried. I have found the Chanalyst very useful checking intermediate frequency and in finding troubles which would have been hard to find otherwise, such as intermediate transformers that show resistance on the Ohmmeter but are still bad."—Emmet Helm.

PHILLIPSBURG, N. J. "I have been in service work 12 years and bought a lot of test instruments. The Chanalyst is the best I ever bought. For intermittents and distortion it has cut my service time 90%, and for coupling condensers, you can test them quicker than you can pick up a soldering iron."—Carl B. Williams, Radio Service Laboratory.

HAZLETON, PA. "I now find it indispensable. . . . The Chanalyst enables you to actually travel through a receiver, everything seems to open up before you."—Residential Radio Sales and Service.

DRYDEN, N. Y. "The Watt Indicator in the Chanalyst, alone, saved me a lot of trouble and time on three sets where the power transformer had been subjected to a heavy overload and was burnt bad. The Chanalyst takes all the GUESS WORK out of servicing."—E. M. Little.

HURON, S. D. "The Chanalyst has changed headache jobs into a pleasure! The one we have has been busy almost continually since we bought it."—Arndt's Radio Service.

SERVICE INSTRUMENTS, Inc.
404 Fourth Ave., New York City

THE FASTEST METHOD OF TROUBLE-SHOOTING

Don't Take Our Word For It . . .

GET A DEMONSTRATION!

Television Tubes

The following tubes have just been announced by RCA for use in experimental television equipment. The three kinescopes are electrostatic deflection types and may be had in white or green screen.

906-P4—Electrostatic deflection type cathode-ray tube with medium persistence green phosphor 5 in. screen.

INTER-COMMUNICATION SET

Plug-in and Talk • No Installation
• Fool Proof •
Fully Licensed and Guaranteed



Room to Room
Upstairs and
Down

House to House
Children's
Playroom

Nursery or
Playroom
House or Garage

Operates on 110 volts
AC or DC

#47 Master Unit
and Sub-Station

Complete with

Wire **READY-TO-USE**. Will operate efficiently with added wire up to 500 feet without additional attachments.

Weight 8 lbs. complete in air-cushioned cartons.

LIST PRICE

\$9.95

COMPLETE

Send for catalogue
showing complete line
up to \$79.50 list price.



REGAL AMPLIFIER MFG. CORP.

14-16 W. 17th St., New York
Cable Address "Ramcoamp"

Special 11 prong base maximum anode voltage 200 volts.

1802-P4—similar to the 1802-P1 but with white screen.

1899—Electromagnetic deflection type monoscope. Provides a source of video signal for television testing.

1802-P1—Electrostatic deflection type cathode-ray tube with medium persistence green phosphor 5 inch screen. Special 11 prong base; maximum anode voltage 2000 volts.

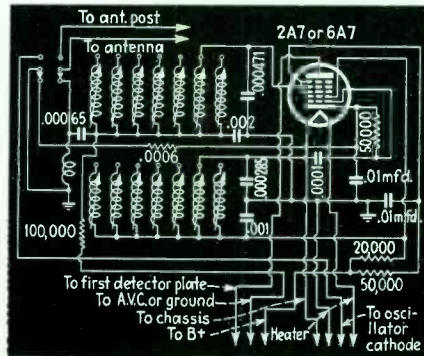

Permeability Tuned P. B. Converter

The Meissner push-button converter the circuit of which is shown here-with differs from most push-button converters as it contains a separate converter tube. This may be a 2A7 or 6A7, depending on the filament voltage in the set to be adapted.

Permeability tuned input and oscillator coils are used. All the input coils have cores of the same high permeability. However, the oscillator coils necessitated the use of a lower permeability core in order to give reduced frequency ratios essential for proper tracking. This might be compared to the difference in plate shape in gang condensers for different intermediate frequencies. In this case, the

difference in permeability of the ganged cores exhibits the same properties as different shape plates.

Connection to the set is made at the first detector, the a.v.c. circuit, and oscillator cathode besides heater, B plus and chassis. The plate of the push-button converter tube is connected in parallel with the plate of the converter tube in the set.

Now... Get **REAL**
RESULTS with
New 1939

BRACH Antennas

Scientifically Designed
to Insure—

- ✓ BETTER RECEPTION
- ✓ EASY INSTALLATION
- ✓ PERMANENCE
- ✓ SATISFIED CUSTOMERS
- ✓ GOOD PROFITS
- ✓ MORE SALES

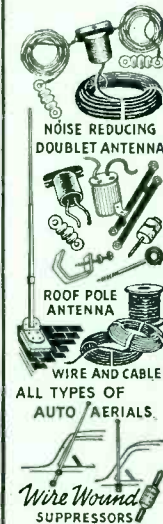

The BRACH line is a complete line and every item is priced right. Large stocks on hand at all times insure prompt deliveries. Send for new catalog today!

World's Largest Makers of Antenna Systems

L. S. BRACH Mfg. Corp.

55-67 Dickerson Street

Newark, N. J.



Established 1906



SOUND EQUIPMENT

Complete sound system in a capacity range to meet every requirement. Compact, powerful and complete with microphone and split twin speaker case. Write for circular.

5 WATTS\$49.95

Handy package system with ample output.

10 WATTS\$79.95

For all around use. Has power to spare.

17 WATTS\$99.95

For heavy duty service. (Amplifier illustrated)

35 WATTS\$149.95

Super heavy duty system for widest coverage.

MILLION SOUND AND TEST EQUIPMENT

A COMPLETE LINE—ENGINEERED TO HIGHEST PRECISION STANDARDS

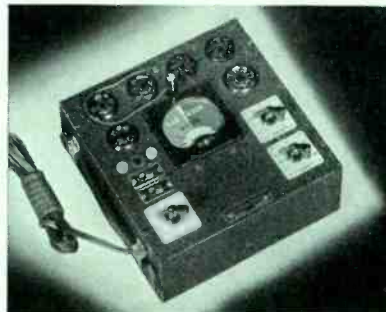

MODEL CP TUBE TESTER

Gives quick, positive 'good-bad' test on all tubes. Super accurate, thoroughly dependable and surprisingly economical.

\$13.95



MODEL MO PUSH BUTTON TESTER

Ultra modern in design and engineering. Provides push button test on all tubes. Oversize meter indicates good-bad condition instantly.

\$18.95

Up-to-date charts always available for Million Instruments.

MILLION RADIO and TEL. LAB., W. OHIO ST., CHICAGO, ILL.

New Tubes

6SJ7, 6SK7—Single ended (all connections brought through the base) r.f. pentodes by RCA similar to the 6J7 and 6K7 respectively. As a result of the new construction, these tubes not only have the same grid to plate capacitance but lower input and output capacitance and higher transconductance. (Operation and construction base pin connections shown elsewhere in the service section of this issue.) Class A characteristics of the 6SJ7 are:

Heater Voltage.....	6.3 volts
Filament Current.....	.3 amp.
Plate Voltage.....	250 volts
Screen Voltage.....	100 volts
Grid Voltage.....	-3 volts
Suppressor (Connected to cathode at socket)	
Plate Current.....	3 ma.
Screen Current.....	.8 ma.
Amplification Factor.....	2500
Plate Resistance.....	1.5 meg
Transconductance.....	1650 Mmhos
Interelectrode Capacity.....	.005 uuf
Input Capacity.....	6 uuf
Output Capacity.....	7 uuf

Class A characteristics of the 6SK7 are:

Heater Voltage.....	6.3 volts
Heater Current.....	.3 amp
Plate Voltage.....	250 volts
Screen Voltage.....	100 volts
Grid Voltage.....	-3 volts
Suppressor (Connected to cathode at socket)	
Plate Current.....	9.2 ma.
Screen Current.....	2.4 ma.
Amplification Factor.....	1600
Plate Resistance.....	.8 meg
Transconductance.....	2000 umhos
Interelectrode Capacity.....	.005 uuf
Input Capacity.....	.6 uuf
Output Capacity.....	7 uuf.

6SQ7—A single-ended metal duplex-diode high mu triode by RCA. Application and operating conditions are similar to the type 75. Base pin connections are: Pin 1—shell, pin 2—triode grid, pin 3—cathode, pin 4—diode plate number 2, pin 5—diode plate number 1, pin 6—triode plate, pin 7 and 8—heater.

6SF5—A single ended metal high-mu triode by RCA with interlead shielding between grid and heater in the base. The shielding reduces hum voltage pickup of the grid lead. Electrical characteristics are similar to the 6F5. Base pin connections are: Pin 1—shell, pin 2—cathode, pin 3—grid, pin 5—plate, pin 7 and 8 heater.

Testing Single-Ended Tubes

Some tube testers have provisions such as extra sockets or positions to accommodate modernization. This may be of advantage to you since the introduction of single-ended tubes.

In the Triumph model 420 and 430 tube testers, a few changes in the circuit will allow testing of the 6SQ7. Pin No. 1 of the special octal socket should be converted to No. 1 of the standard octal socket; terminal No. 2 of the special to No. 8 of the standard.

“reasons why”
IS THE BIGGEST SELLING
CAPACITOR LINE

CORNELL-DUBILIER CAPACITORS

QUALITY BUILT

EXPERIENCE TESTED

ECONOMICALLY PRICED



The type BR Blue Beaver is a typical example of the C-D “experience-tested and quality built” capacitor line. Hermetically sealed and vented, they eliminate drilling of chassis, use of pal nuts and washers as well as minimize assembly operations. You’ll like the results you get from C-D’s NEW Blue Beavers.

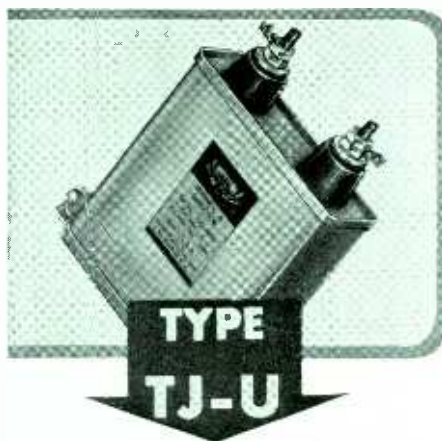

Type TJU fireproof Dykanol transmitting capacitors come hermetically sealed in sturdy steel containers. These are the capacitors practically every broadcast and government station in the world uses today. Standard equipment too, with tens of thousands of “hams” who will buy nothing else but C-D Dykanol units.

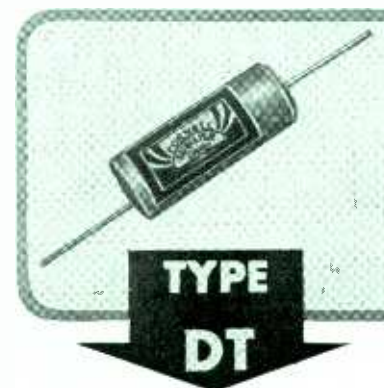

C-D famous “Dwarf-Tiger” paper tubular capacitors are non-inductively wound and specially sealed. Extensively used by leading set manufacturers, C-D has produced millions of these tubulars—more than any other company in the world. Type DT is a real quality capacitor at the lowest price ever offered.

CATALOG NO. 161
NOW OFF THE PRESS! Have You
Enough Copies?

CORNELL-DUBILIER
ELECTRIC CORPORATION
1019 Hamilton Boulevard, South Plainfield, New Jersey

**QUALITY TESTERS
at LOWEST PRICES**



Positively Checks Radio Receiving Tubes According to Latest Recommendations of Tube Engineers.

NEW MODEL 432 TUBE TESTER Only \$21.60

- Separate Plate Tests on Diodes and Rectifiers
- Neon Short and Leakage Tests
- Ballast Tube Continuity Test
- Uses Attractive Complete in attractive, sturdy quartered-oak case; suitable for counter or portable use. Sloping etched panel of silver and black. Also Available:
- Triplet Direct Reading Instrument 3" size. (GOOD-BAD) Scale
- Line Voltage Adjustment
- New Improved Low Loss Switch

MODEL 431 \$15.90

Checks all receiving tubes. (No ballast test.) Tester uses dependable Readrite Meter. Quartered-oak case same as for Model 432.

★ ★ ★

A.C. and D.C. VOLT-OHM-MILLIAMMETER

MODEL 736 ONLY \$12.00



POCKET SIZE

Sturdy molded case with rounded corners, accessories included.

READRITE METER WORKS
1120 College Avenue, Bluffton, Ohio

Please send me more information on
 Model 432; Model 736; Send Catalog

Name

Address

City..... State.....

Self-Balancing Phase-Inverter

In the usual two-tube phase-inverter circuit, a portion of the output-signal voltage of a tube is applied to the grid of a second tube in such a manner that the signal voltages between plate and ground of tubes are equal in magnitude and 180 degrees out of phase. In such a circuit, the proper phase relation between these is obtained automatically; the amplitude of these voltages is made equal by adjusting the portion of the voltage that is fed to the grid of second tube. An analysis of this circuit, which is representative of two-tube phase-inverters reveals an important disadvantage; possible variations between different tubes of the same type and variations in the balance resistor value produce corresponding variations in the output voltage.

A self-balancing phase-inverter circuit that does not have this disadvantage is shown in Fig. 1. Resistor R_3 , connected between ground and point

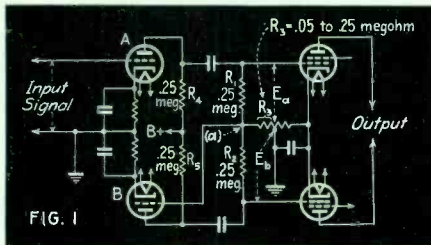

(a) is common to the plate circuit of tube A and to plate and grid circuits of tube B. Because of this common connection, the magnitude of the signal voltage across R_3 , which is applied to the grid of tube B, depends on the difference between the values of output-signal currents of tubes A and B. Hence, the effects of variations in the value of R_3 or the effects of possible variations between different tubes of

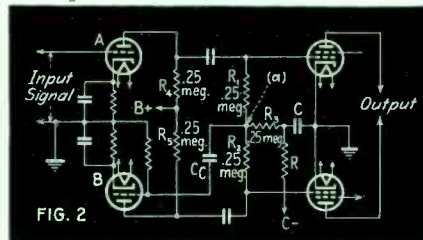

the same type used in position B are very small. The circuit is degenerative, because a portion of the output of tube B is fed back to the input of tube B. Hence, the stability that is characteristic of degenerative amplifiers is obtained.

The voltage E_a and E_b cannot be made equal with this self-balancing circuit by any adjustment of the value of R_3 because of the degenerative action. However, with the values of resistors ordinarily employed in this circuit these voltages are approximately the same. (A 10 per cent unbalance in the push-pull output stage of a radio receiver can be tolerated easily.)

The output tubes in the self-balancing phase-inverter circuit of Fig. 1 are self-biased. When the bias for these tubes is obtained from a fixed or partial-fixed-bias source, it is necessary to couple the grid of tube B to point (a) through a suitable condenser (C_c), as shown in Fig. 2. In addition, a hum filter (R and C in Fig. 2) may be required, because most partial-fixed-bias sources contain appreciable hum voltage; any hum voltage appearing across the grid resistor of tube B is amplified by tube B and by one of the output tubes.

Under many operating conditions, this circuit requires no more components than conventional circuits, and at the same time offers advantages of high stability and freedom from balance adjustments.



UNIVERSAL BENCH—Complete, self-contained bench of A. O. Edlund, Janney Semple Hill and Co., Minneapolis, tests 110 volt a.c. or d.c. sets; 7 volt farm set; 6 volt auto sets, and 32 volt and 2 volt farm models. Service in the area covers a variety of makes, models and voltages.

Go After
The
"PERMANENT"
PROFITS
with



BELL SOUND EQUIPMENT!

A new and bigger market is open to you—and it's a profitable one! Churches, schools and all types of commercial organizations are today becoming "sound-conscious." They are realizing the importance of good sound facilities, and are installing modern sound equipment for permanent use. With Bell's complete line of permanent and portable Public Address systems, you can get this business—and the profits! The proved performance, remarkable tone fidelity, striking appearance and surprisingly low prices of Bell equipment give you a real advantage in closing sales—and they speed up your cash returns. Write today for complete details on Bell Sound Equipment, and get after these "permanent" profits!

A Powerful 60-Watt Amplifier At Low Cost

Model 460, shown above, is a powerful 60-watt unit that has features not found in many far more expensive sets. It has "everything," including: Bass and treble compensators, automatic volume expansion and compression, master gain control, beam power tubes, inverse feed-back, five input channels, provision for phonograph attachment, 15 tubes and 6 stages. Like other Bell units it is built to highest standards throughout. Write for details.

BELL SOUND SYSTEMS, Inc.

1185 ESSEX AVE.

COLUMBUS, OHIO

*Our Hats
in the Ring!*



• Those new green-finished CLAROSTAT wire-wound power resistors are cement-coated. But it's an entirely different kind of inorganic cement. Based on years of search for the ideal coating, the results are simply astounding.

Try this Test . . .

Take one of these units. Run it at twice rated wattage. Get it red hot. Dip in cold water. Test for resistance value. Look for cracks. Then try the same test on any vitreous-enamel or other type resistor. Just try it!

Free MANUAL . . .

Write for descriptive data. Also pocket-sized 208-page service manual. Meanwhile, ask your jobber for those green power resistors and those new midjet controls.

CLAROSTAT *Manufacturing Co., Inc.*



285-287 NORTH SIXTH STREET
BROOKLYN, NEW YORK, U.S.A.

• OFFICES IN PRINCIPAL CITIES •

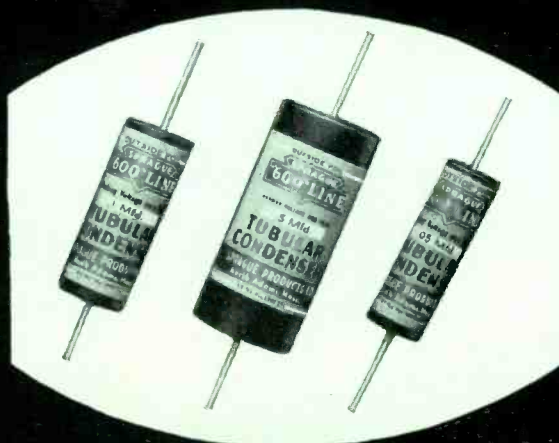

Maybe we should have
told you LONG AGO . . .

Said the sales manager to the man who writes these ads: "Hy, do you realize there are 60 million Americans who have no direct knowledge of the World War? Either they were not yet born, or were less than 6 years old when the War ended. Time marches on! That's why you ought to say something about TC Tubulars soon. Maybe there are newcomers in Radio who don't know all about the most famous condensers that ever came down the pike."

So here goes: Since first Sprague TC Paper Tubulars started to make famous the slogan "Not a failure in a Million!" there have been many developments, many imitations, many attempts to beat Sprague quality—But still TC's remain the fastest selling tubulars on the market, and certainly the most reliable.

Just ask the best technical men you know. Go to the fellows who don't buy their condensers because of advertising claims, but who buy them on the strength of hard-boiled engineering tests. What they tell you about TC's will prove more convincing than any pretty adjectives we might print here. They'll tell you a lot about construction, non-inductiveness, moisture-proofing, safety factor, etc. that might make pretty dry reading but that makes a mighty convincing demonstration against any competition you care to name.

Maybe we should have written this ad long ago. But sometimes it's hard to realize that maybe even the world's most famous condensers won't walk out and sell themselves—that is, unless we tip folks off once in a while to investigate how good they really are.



SPRAGUE

GOOD CONDENSERS—EXPERTLY ENGINEERED—
COMPETENTLY PRODUCED

SPRAGUE PRODUCTS CO., NORTH ADAMS, MASS.

Better RESISTORS



● Fit companions for AEROVOX condensers. These AEROVOX resistors are the product of constant refinement over a decade and a half. You'll be surprised how good a wire-wound or a carbon resistor can really be. Yet they cost no more.

PYROHM JR.

● A lot of power resistor in a mighty small size. Due to use of better grade materials. Quality resistance wire. Crackproof refractory tubing. Coated with powdered glass enamel fired at red heat. Vitreous enamel tightly fused to wire, terminal connections, tubing. 10 and 20 watts. Popular resistance values.

SLIDEOHM

● Same specifications as above but with adjustable slide band contact. Any resistance value and tap within unit's range. Additional contact bands at slight added cost. 25, 50, 75, 100 and 200 watt ratings. Popular values.

Ask Your Jobber...

● If he handles AEROVOX condensers and resistors, he can show you these superior resistors. Try them just once. Convince yourself of their stay-put qualities. Latest catalog on request.

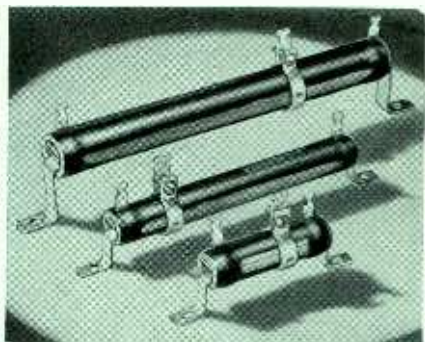

T R I C K S

DELCO R1119

Tuning eye inoperative, no plate voltage on 6L7 tube . . . shorted .01 bypass condenser and burned 15,000 ohm resistor. Replace both resistor and condenser.

GRUNOW 11A

Distortion after 15 minutes operation . . . check coupling condenser between 85 second detector and 76 push pull drives.

MAJESTIC 15

Dead . . . try a new 24A tube in the oscillator socket. Some tubes will oscillate strongly, while others not at all.

PHILCO 20

Intermittent or noisy, okeh when antenna is connected to second r.f. grid . . . high r.f. resistance in plate coil of second r.f. stage.

PHILCO 38-5

Noisy, intermittent or dead . . . check screen dropping resistor No. 21 in diagram. This is a 10,000 ohm 1 watt unit. Replace with wirewound type.

PHILCO 60, 505

Noisy . . . check .18 mfd cathode bypass on 6A7 tube.

RCA VICTOR 260

Intermittent . . . failure of .05 mfd a.v.c. filter condenser in the r.f., first detector, and r.f.

RCA VICTOR 867

Dead on dial tuning, operative on push-button tuning . . . look for shorted stator on oscillator tuning section of gang condenser.

RAC 6K2

Inoperative on broadcast band only . . . investigation showed evidence of mice. Layer of moisture between broadcast band, mica trimmer shorting plates. Remove trimmer, clean thoroughly and insert new mica separators.

RCA 9K

Set dead, no screen voltage . . . Check candohm resistor mounted under rear of chassis. Resistance should be 22,000 ohms.

RCA 9K1

Cutoff on strong signals . . . Check mica condenser coupling r.f. stage to first detector.

RAC D-11-2

Oscillation on high frequency end of short wave band . . . Check oscillator grid resistor. This resistance is mounted on top of the tuning condenser.

SILVERTONE 1640

Motorboating . . . replace the screen bypass on the i.f. amplifier.



recommends



● The above illustration shows both the inside and the outside view of COR-NEX, installed on the job and ready to function—a superb invention by a practical service man, which eliminates for all time the sloppy, dangerous connections housewives have for too long put up with. You make a real profit on this one! And how your customers will thank you! Easy to install. Hailed by service men as the greatest innovation in years.

COMPLETE—with DOUBLET lightning arrester, decorative inside plate with leads and polarized plug with cords. List. **\$2.50**



A masterly A.A.&K. licensed system that abolishes man-made static on broadcast as well as shortwave bands. Improves reception in ANY location. Gives your set a CHANCE! Several units at attractive prices.

Distributed through Jobbers

CORNISH WIRE CO., Inc.
30 Church St., New York City



NEW!
Model CC

SOLAR

CAPACITOR ANALYZER

This advanced new model has all the good features of our famous CC model . . . PLUS high capacity scale, high test voltage, simplified scales and sloping panel. A.C. operated. Illustrated model, No. CC-1-60, for 110 volts, 60 cycles operation, less tubes, costs \$24.90 Net . . . through your jobber.

SOLAR MFG. CORP. 599 Broadway, New York

This Combination Means **MORE PROFIT** FOR *You!*



ARCTURUS DEALER HELPS!

If you have not yet received your copy of the ARCTURUS DEALER HELPS folder, send for it today! Here's everything you need to win the big sales contest that goes on right in your own store—every day! New displays; new, up-to-the-minute sales promotional items; new office and store necessities; new electros and mats . . . most of them absolutely FREE to ARCTURUS dealers! Use these tested sales-builders to bring new customers into your store and to keep the old ones coming to you again and again.

RADIO'S FINEST TUBES!

When you sell ARCTURUS TUBES you sell top quality. ARCTURUS' outstanding achievements in tube design . . . skillful workmanship . . . careful inspection . . . make ARCTURUS TUBES the finest engineered tubes on the market today. That means satisfied customers and increased tube sales for you!

SHORT WAVE CONVERTERS FOR CAR RADIOS

Can be attached to any car radio. Has on and off switch. Does not affect the reception on the standard broadcast bands. MODEL 600—covers 49, 31, 25, 20, 19 and 18 meter bands. Designed for reception of American and Foreign short wave broadcast. Especially adapted to use in tropical countries and the more remote parts of the world. Distance range 5000 to 10000 miles. A very attractive unit. List Price \$24.95

For Use of Police and Other Law Enforcement Officers

MODEL 100-A police converter with Model 100-A fixed condenser. Covers 1500 to 2600 kilocycles. List price \$13.50.

MODEL 200 police converter with variable condenser and illuminated dial. Covers 1500 to 5500 kilocycles. List Price \$17.95.

MODEL 500—police converter with two metal tubes, variable condenser and illuminated dial. Very sensitive. Exceptional distance range. List Price \$21.95

MODEL 800—with fixed condenser, two metal tubes. Long range. List Price \$15.95

Jobbers and dealers wanted **ABC RADIO LABORATORIES** 3334 N. New Jersey St., Indianapolis, Indiana, U.S.A.

The IMPROVED ARCTURUS EQUIPMENT DEAL!

Better, more complete than ever—with a new assortment of the very latest models — the ARCTURUS EQUIPMENT DEAL enables you to equip your shop with the most efficient test equipment money can buy . . . at almost no cost to you! Lower Down Payments . . . Low Tube Requirements . . . Tubes at Standard Prices . . . Immediate Delivery of the equipment you select! ARCTURUS actually gives you EXTRA PROFITS in the form of this valuable, modern equipment!

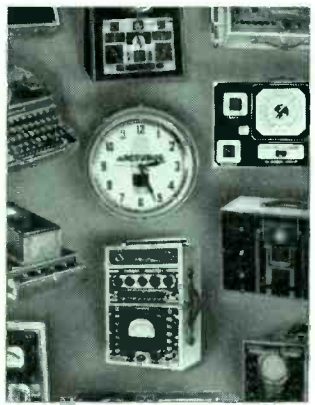

GET THE FACTS! Send for your FREE copy of the ARCTURUS DEALER HELPS folder and full details on the new items just added to the ARCTURUS EQUIPMENT DEAL. DON'T DELAY . . . put this profit-making combination to work for you at once! Mail the Coupon!

New! Faster! Better!

JACKSON

DYNAMIC TUBE TESTER

The ONLY Dynamic Tester in the low priced field. Built to the same rigid quality standards which have made JACKSON testers famous for accuracy. Neon Shorts Test—Full Range Line Control—All Readings Direct—Tests Each Section of Multi-purpose Tubes. Ideal for portable or counter use. Complete with snap-on metal lid.

ONLY \$24.95

On Display at Your Jobbers Now—or write for full details.

THE JACKSON ELECTRICAL INSTRUMENT CO., Dayton, O.

ARCTURUS

ARCTURUS RADIO TUBE CO., Newark, N. J. R-13

Without cost or obligation, send my copy of the ARCTURUS DEALER HELPS Folder and details of your new equipment deal.

Name.....

Street.....

City..... State.....

I am a dealer I am a serviceman My jobber is.....

For your convenience this coupon can be pasted on a penny postcard

908

"NEW!"

WARD'S DE LUXE HOME AERIAL MAST

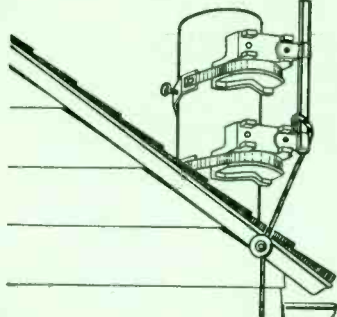

- Can be sold to replacement market as well as with new sets
- Provides better reception, better pickup than old style "clothes-line" aerials
- Made of attractive, rustproof, nickel-plated bronze tubing; 4 sectional; 12 ft. high
- Easy to mount to soil pipe, or against chimney, window frame, garage, etc.

FREE! Write today for free catalog of WARD'S complete line of aerials for car and home.

The WARD PRODUCTS Corp.
WARD BUILDING CLEVELAND, OHIO

SILVERTONE

Noise control on rear of chassis burns up . . . look for short in plate circuit of 6A8G tube near plate terminal of socket. Replace control with 750 to 1100 ohm pot.

SPARTON 410, 420

Intermittent. . . inspect the resistor block for loose connections.

SPARTON 600

Strong hum when set is tuned to resonance with a signal . . . replace .006 mfd condenser connected from one side of power transformer to ground with a .5 or 1 mfd unit. It is important that this condenser is of the non-inductive type.

STEWART-WARNER R116X

Dead . . . replace oscillator plate resistor with 20,000 ohms, also replace the condenser at B plus end of this resistor with .1 mfd.

TRUETONE 7J

Weak . . . Shorted .25 mfd bypass in screen of output tube. This usually burns the 20,000 ohm resistor in same circuit.

Now! BALLAST REPLACEMENT

made **AMAZINGLY SIMPLE**

- Servicemen, with only 4 standard types of Amperite AC-DC Regulators you can replace 90% (over 100 types) of AC-DC Ballast Tubes now in use! Consult your jobber.
- Amperite Regulators are equipped with a patented Automatic Starting Resistor to prevent untimely burnouts and save pilot lights.
- New Low Price on Amperite AC-DC Regulators: \$1.00 LIST

Amperite Replacements for 2V Battery Set ballasts \$1.25 list



AMPERITE Company
561 BROADWAY
NEW YORK

WRITE FOR CHART AR

AMPERITE
AUTOMATIC REGULATORS

SOLAR's rich experience originated "little giant" etched foil ultra-compact electrolytics . . . the overwhelming choice of service men seeking MORE for their money. Largest selling and most reliable of its type. Sold by jobbers everywhere.



SOLAR MFG. CORP., 599-601 BROADWAY, NEW YORK

YOU
Take the Premiums
I'LL
Take the
PROFITS



THAT just about sums up the attitude of hundreds of Servicemen and Dealers who have come to learn that Fancy Deals, Inside Propositions can never be a substitute for a quality product with real not fancied profits. TRIAD TUBES have a "cut and dried", "open and shut" proposition: Honestly built, quality tubes at a price that gives you a LONG, LONG, PROFIT. Get our new proposition and judge for yourself!

TRIAD THE QUALITY NAME
IN RADIO TUBES
MANUFACTURING CO., INC.
PAWTUCKET, RHODE ISLAND

UNIVERSAL 5-10

Bad hum, both tunable and constant1 mfd condenser from the high side of the 400 ohm choke omitted but shown in diagram.

ZANNEY GILL

Oscillation . . . Check all bypass returns which are made to rivets. Soldering these rivets to the chassis will effect a cure.

ZENITH 5907 AND 1207

Distortion, sounds very much like blocking a.v.c. action . . . look for open filter condenser section.

ZENITH 1502

Wont log . . . loose Parker-Kalon screws in gang hub gear.

ZENITH 52

Noisy at intervals . . . replace bleeder resistor, apply small amount of vaseline to volume control.

ZENITH 755

Fades out after few minutes of operation . . . defective heavy duty resistor connected from filter condenser to push-pull transformer.

ZENITH 5647

Blown ballast tube . . . before replacing tube check C9, a 40 mfd condenser connected to cathode of 25Z6. If defective, replace.

ZENITH 6D-166

Dead . . . check .02 mfd. tubular condenser connected to one end of the volume control. Replace condenser, leaving enough slack in the lead to prevent pulling the condenser lead loose by a slight movement of the control.

ZENITH RADIORGAN

No control of tone . . . insulation on 33,000 ohm resistor cut through, shorting to cathode lug.

Too much tone control on some buttons, none on others . . . tone condenser or switch leads shorted.

Tone changes with different settings of volume control . . . defective volume control or shorted terminal, either of tone switch or volume control. Poor volume control contacts or shorted taps.

Noisy when tuning . . . dirty condenser gang wipers or plates; fly-wheel touching band switch lug; volume control or drive shaft not making good contact to ground.

Volume control has two peaks and distorts at low volume . . . isolate 6F5 grid circuit from i.f. plate leads. (Later sets have this lead shielded.)

ZENITHS 1938

Noisy tuning on short wave band . . . remove dirt and grease insulating the condenser drive shaft from ground. This can be accomplished by removing condenser and switch shaft and cleaning with carbon tetrachloride. Also clean shaft bearing.

In the 5 tube a.c. models a common trouble is no reception below 1200 kc. This is due to an open primary in the oscillator coil. Shunt this winding with a 10,000 ohm resistor and circuit returns to normal.

In 15 tube models, distortion at low volume is sometimes encountered. This

is due to a small amount of r.f. getting through to the audio system. To remedy: insert a .0005 mmf condenser in series with a 150,000 ohm resistor from first audio grid to ground.

Battery Sets. In receivers of this type using a 1A6 or 1C6 pentagrid converter it is common that this tube refuses to oscillate or has short life. A simple remedy is to drop the screen voltage by inserting a 50,000 ohm resistor in series with the screen. A .1 mfd condenser should then be connected from screen to ground. Care should be used to see that the resistor is not placed in a circuit that will drop the screen voltage on all tubes.

A Plain Statement of Fact Concerning
DYNAMIC MUTUAL CONDUCTANCE

Important Information for the Protection of the Radio Service Industry.

A

TUBE TESTER TO TRULY MEASURE DYNAMIC MUTUAL CONDUCTANCE SHOULD READ IN



MICROMHOS

JUST AS A WATTMETER READS IN WATTS OR A VOLTMETER IN VOLTS

Meter used in HICKOK T-53 TUBE TESTERS. RANGE: 0-3000-6000-15,000 MICROMHOS.

Dynamic Mutual Conductance in Micromhos is the accepted method of tube testing among all manufacturers and tube engineers. Hickok has pioneered and perfected Dynamic Mutual Conductance Tube Testers for the past fifteen years. An accurate, modestly priced tester is the result. Manufactured under U. S. Patent No. 1,999,858.

Hickok has also pioneered these advanced designs: Zero Current Voltmeters—infinite ohms per volt; Signal Generators with power level meter and output calibrated in microvolts; Oscillographs with built-in modulators and demodulators and video amplifiers; New Crystal Controlled service generators. *Fill out the coupon below.*

THE HICKOK ELECTRICAL INSTRUMENT CO.
CLEVELAND, OHIO

.....
The Hickok Electrical Instrument Co., 10513 Dupont Ave., Cleveland, Ohio

Gentlemen: Please send information on:—

<input type="checkbox"/> Dynamic Mutual Conductance Tube Testers.	Name
<input type="checkbox"/> Calibrated output and crystal controlled Signal Generators.	Address
<input type="checkbox"/> Zero Current Voltmeters.	City..... State.....
<input type="checkbox"/> Giant Volt-Ohm-Milliammeters.	
<input type="checkbox"/> Other Apparatus as follows—	

*Fill Your Pockets by
Filling Sockets with*

PHILCO TUBES

*Here's what a tremendously
successful radio serviceman
says about Philco Tube Sales:*

"I concentrate on *Philco* tubes because they are the easiest tubes in the world to sell. Here's why. First, about **ONE** out of every **FOUR** radios in use today is a *Philco* . . . and *Philco* owners naturally want and demand *Philco* Tubes. Second, the prestige and public acceptance of the name *Philco* causes a big percentage of owners of other make radios to specify *Philco* when they need replacement tubes."

You, too, can cash-in on *Philco's* overwhelming popularity . . . and fill your pockets by filling sockets with **PHILCO TUBES!**



The Easiest Tubes in the World to Sell

SOUND In New England

A Survey

By FRED MERISH

COVERING radio retailers in a recent survey of the New England, we find that those dealers who are selling sound aggressively receive substantial returns for their efforts. In every instance, where the dealer was merchandising sound energetically, he reported profitable results. The net profit on sound sales averaged 14 per cent, according to the figures submitted to us. This is a better-than-average retail net today and shows conclusively that sound is a sound merchandising proposition.

Our survey work sheets on sound classify radio retailers, as follows: 15 per cent promoting sound aggressively, 20 per cent selling sound in limited volume because they are making only half-hearted attempts to sell it, 35 per cent considering merchandising sound equipment, 30 per cent having made no effort to sell sound and seeming apathetic to its possibilities.

Many Dealers Missing Boat

This survey brought into bold relief two definite facts, that sound has excellent selling possibilities for those who go out after the business; that too many radio retailers are losing money by not promoting sound equipment aggressively. In one typical case, a radio dealer alive to sound profits sold a PA outfit for \$350 to a dancehall operator in a town 20 miles away, yet another radio dealer across the street from

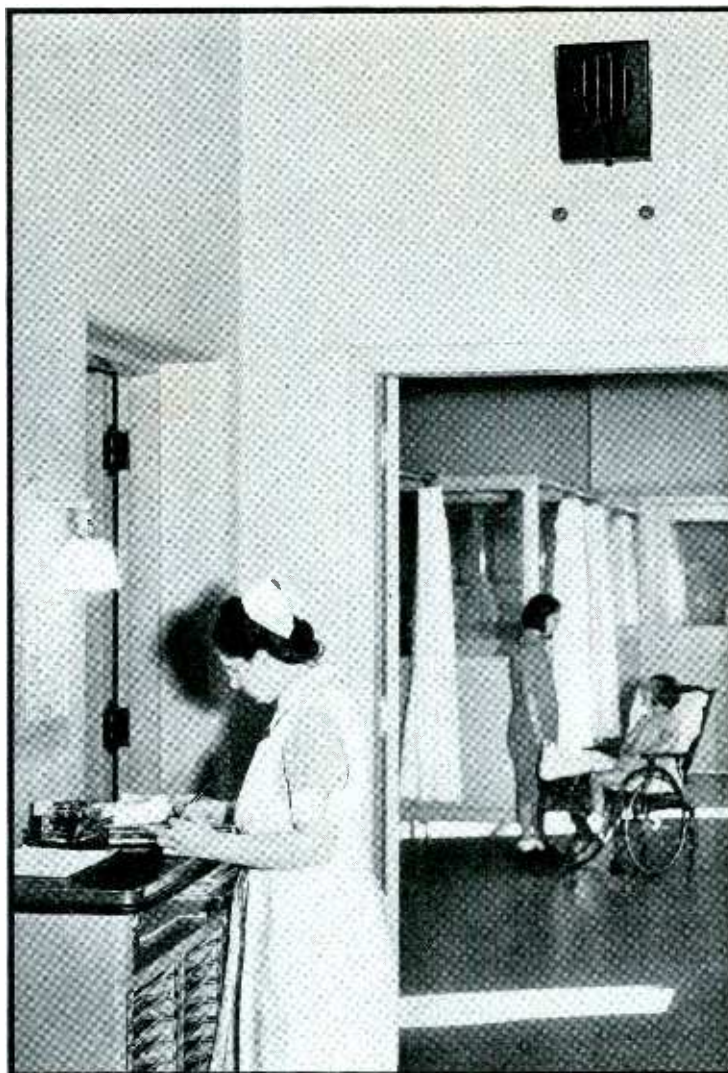

ONE OF MANY USES—Selective paging system installed in the Rochester (N. Y.) General Hospital by Stromberg-Carlson. From a central switchboard via low-toned, low-volume speakers go mellow chimes calling doctors to clinical meetings. A metronome's soft ticking summons the night nursing supervisor. A high-frequency buzzer brings the night watchman. Morse code on a muted telegraph sounder brings others. Voice is used only when necessary and so irritation of patients is avoided

this dancehall, never tried to contact the prospect. As another indication that some dealers are more alert than others to sound possibilities, we found comparatively few installations at one of the largest beach resorts on the eastern coast, whereas, at some of the smaller lake resorts there were 40 to 50 sound jobs at the local hotels and at ballyhoo marts. Here is good summer business.

Sales by radio retailers were reported as from \$50 to \$1,200. Unit sales on equipment averaged \$125 for the dealers contacted, 70 per cent cash. Financing is generally

done through regular finance companies or through banks, usually 25 per cent down, balance over year.

Natural For Outside Selling

Outside sales work is absolutely necessary to sell sound in substantial volume. The seller's ingenuity and imagination are all that limits sales because prospects are everywhere—in commercial establishments, industrial plants, amusement places, churches and municipal institutions. The best salesmen are those with acoustical training. Those with an understanding of

SOUND IN NEW ENGLAND

(Continued from page 81)

electrical installation are next best, but dealers stated that these types are rather hard to find, hence it becomes necessary to train many salesmen along these lines.

Outside salesmen average 10 per cent commission. The average income computed from our survey work sheets is \$55 weekly. To get best results, salesmen should carry demonstrating units. In some cases the salesmen's cars were equipped with loudspeakers and amplifiers so that they could give demonstrations outdoors and indoors, the equipment operating on battery or electric current and changed over in a few seconds. Night calls are essential with certain prospects, such as dancehall and night-spot operators. Some salesmen report that 50 per cent of their sound sales are made at night.

As reported to us, calls average 25 daily, interviews 15 daily, including night work. Canvassers on other lines average more calls than sound salesmen but fewer interviews, because they work door to door with many outs or they carry products which are more limited in appeal. The ratio of immediate sales to calls is 1 out of 25 with an average of 5 good suspects in the kitty likely to buy someday. That may mean tomorrow or 6 months from now. Dealers report that Saturday is not a good day to canvass because some business houses close all day, others a half day, while amusement places are too occupied. . . . Saturday, however, is a good day for rental sales.

Brings in Radio Sales Too

Frequently sound salesmen bring in radio sales. A dealer in Massachusetts stated that his sound salesman averages \$400 monthly in pickup radio sales through contacts with office executives, shopkeepers, industrialists and municipal workers on sound equipment. Sound is therefore a radio sales booster, which is all the more reason why radio dealers should push it energetically.

Little turnover on sound salesmen was reported. The reasons

given for the relative permanency of a sound sales force are:

1:—This equipment is finding ready acceptance.

2:—Less competition on sound equipment. So few dealers have realized its profit possibilities to date that outside salesmen have comparatively easy riding.

3:—Sound equipment does not become outmoded or obsolete quickly, hence, salesmen do not experience as much sales resistance because of style changes.

4:—Salesmen need to use little physical energy to sell sound because prospects are virtually everywhere. Products longer on the markets have acquired so many users that non-users are harder to find.

5:—Because sound means more profit to the purchaser, it has tremendous selling appeal. It is harder to convince a prospect to spend money for abstract benefits, such as comfort, convenience, more modern equipment or styling, than to induce sales of equipment that saves money or increases earnings for the purchaser. Sound is an expense-reducer and a sales-builder.

Promotion Methods Simple

Dealers find that "Use the user" methods are effective. Salesmen make a practise of taking prospects to listen to installations in actual operation whenever feasible. Ninety per cent of sound prospects who listen to good user installations buy, say the dealers contacted. This indicates the importance of making first-class installations, which in turn means getting profitable prices, not cutting prices and skimping installations.

Next to personal contacts, dealers report that direct-mail is effective in getting "bites". Sound is something new. One dealer reported 40 "bites" out of 100 letters addressed to a selective list of institutional, commercial and industrial prospects. A five per cent return on direct-mail for a proposition involving a

substantial cash outlay is high. Sales made from direct-mail average 8 per cent on mailings.

Inter-Coms, Recorders

Aggressive sound dealers state that intercommunicators are also profitable sellers. Outside salesmanship is needed with this line too. Frequently, salesmen, after interviewing office executives, sell them intercommunicators for their homes as well as offices. Dealers state that it is best to use special salesmen on intercommunicators where the territory is extensive enough.

Office executives, industrialists, professional men, shops, banks, schools, institutions and homes are the best prospects. Sales reported ran from \$35 to \$500. The average unit sale was under \$100. Ninety per cent of the active sound dealers also sold intercommunicators, hearing-aids for the deaf, phone-attachments and recorders.

One dealer sold seven recorders in six weeks, \$150 each. He gets prospects interested by having them record a few words in his show-room, then lets them listen to the playback. He says this stunt is tops as a sales-seducer. Prospects, intrigued by their canned voices, spread the word. Music teachers and voice culture teachers, also schools are good prospects.

His demonstrator has paid him four times over in recordings. One week he had fifteen appointments to make recordings in homes. He charges \$2.50 machine service fee per recording plus the price of the blank record. Recently, he made 250 recordings in a school and at the end of the next term will make 250 more to show the progress made by pupils. In large quantity recordings dealers set special prices.

Sound apparently knows no seasons in New England. It's an all-year-round seller.

This survey convinces us that sound is a sound proposition for radio retailers. It talks real money all the time.

Handbooks, Catalogs, Displays

RECORD CHANGER CATALOG—*Garrard Sales* of 17 Warren, New York, American sales rep for Garrard Engineering and Manufacturing of Swindon, England, has a new booklet listing its complete imported line of automatic record changing units and record players. On request, no charge.

JOBBER CATALOG SHEETS—Loose-leaf 8½ by 11 sheets describing the complete *Clarostat* line of radio parts and accessories and particularly designed for use by counter and jobber salesmen are available. Address the firm at 285-7 North Sixth, Brooklyn, New York, on business stationery for details.

TRANSFORMERS, TRANSMITTERS—*United Transformer* of 72 Spring St., New York has two new catalogs. One, covering replacement transformers, contains many pages of dope regarding the requirements of existing receivers plus specifications on units made for use in such sets by the company. The other describes special series transformer components and amplifier and transmitter kits.

BATTERY BOOSTER—*Bond Electric* of New Haven offers a flashy counter card featuring its new 700-foot Fixt Focus flashlight.

CATALOGUE 738—Write the *Cinadagraph Corporation* of Stamford, Connecticut for it if you want to know complete electrical, acoustical and mechanical details on this firm's unique line of speakers.

CAT RAY CATALOG—Complete details regarding all the tubes, testers and television equipment made by the *Allen B. DuMont Laboratories* of Passaic, N. J., is contained in this firm's new catalog for 1938-1939. Sent on request to established servicemen and technicians.

TUBES—*Ken-Rad* of Owensboro, Ky., is distributing a new series of display material including four window cards, a window trim set.

NEEDLES—“The Truth About Phonograph Needles” is the name of a new pamphlet put out in the interest of *Walco* sapphire-point needles.

MIKE DATA—*Universal Microphone Company* of Inglewood, California, has a new 16-page catalog, offers it without charge to *Radio Retailing* readers.

DOPE ON BRIDGES—Theory and practice necessary to handle a capacity and resistance bridge properly is contained in a new manual offered at 50-cents per copy by the *Aerovox Corporation* of 70 Washington St., Brooklyn, N. Y. It is supplied free of charge to users of the company's new instrument.

WESTON BENCH PLANS—Data sheets containing complete constructional specifications of Weston's prize service bench are shown below. Available in two types, the deluxe model, illustrated at right, is shown in schematic directly below. The standard model, with simplified design and constructional details, and without rounded corners, may be seen at bottom of page. Both are obtainable free by writing Weston Electrical Instrument Corp., 581 Frelinghuysen Ave., Newark, N. J. or *Radio Retailing*.

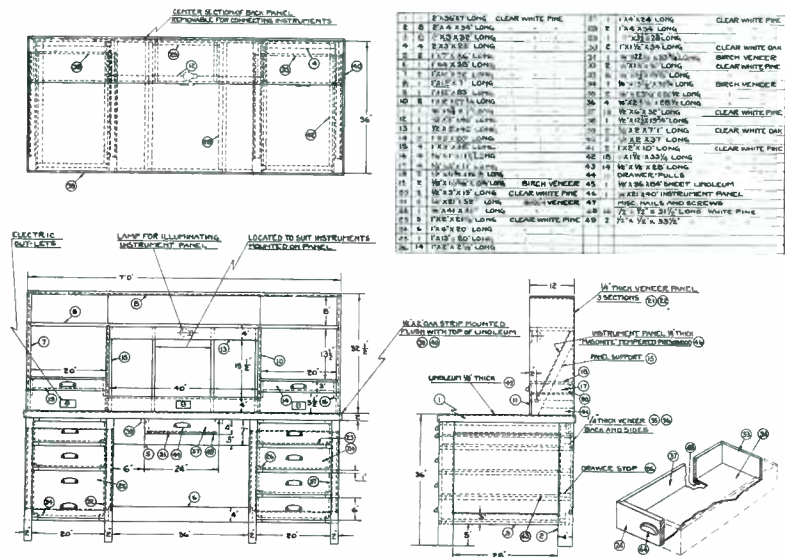
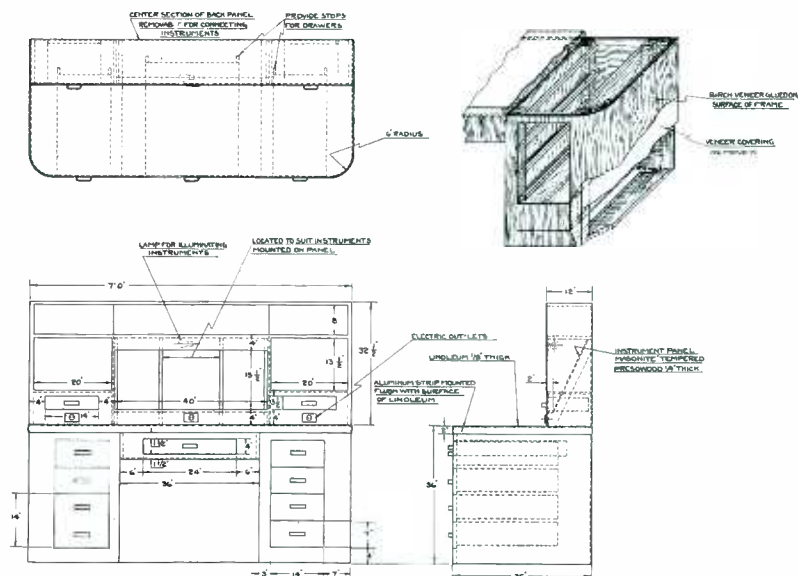

SCHOOL—Capitol Radio Engineering Institute of 3224 16th St., Washington, D. C., has a new catalog completely describing the various courses it offers, picturing facilities provided by the school's new building.

PICKUPS—From Audak Company, 500 Fifth Ave., New York, comes a new booklet cataloging and picturing the complete Audax line, including the latest "compensated microdyne" models. Illustrated and in color, the booklet is offered to *Radio Retailing* readers writing direct to the manufacturer.

TIEUP—Tieing in with current campaign national advertising is an Emerson window display carrying a reprint of a full-page full color ad appearing October 23rd in a widely read weekly. Features radio models from \$9.95 up. Excellent display centerpiece.

DISPLAY—Radio City Products of New York announces a new die-cut counter and window display incorporating the latest principles in merchandising. Features two low-priced, high-quality tube testers.

HARDWARE—Offered by the Federal Sales Company of 24-26 South Jefferson St., Chicago, is an illustrated 15-page catalog of hardware for radio, sound, television, electrical and specialty apparatus. Includes quantity prices. Catalog 51 sent to dealers, servicemen writing on company stationery.

CAPACITORS—New is a capacitor catalogue covering the complete line of the Tobe Deutschmann Corporation, Canton, Mass.

PHOTOSWITCHES — Photoswitch, Inc., 21 Chestnut St., Cambridge, Mass., announces a new folder describing its line of photoswitches for industrial and semi-industrial uses. Applications pictured.

INVENTORY CONTROL—Inventory control is the subject of a new booklet by the Hytron Corporation of 76 Lafayette St., Salem, Mass. Breaks radio tubes up into groups, selected in accordance with frequency of consumer demand. Useful in fitting stock to pocketbook.

CONCENTRIC — Technical data, prices on CO-X concentric cable made by Transducer Corporation of 30 Rockefeller Plaza, New York, is contained in a new data sheet offered the trade. Applications include amateur transmission lines, television; photoelectric cell cables, auto and home antenna leads, aircraft radio and precision instruments.

TUBE BANNER—*Tungsol* offers a 3x6-ft. giant canvas banner featuring the words: "Radio Service By Radio Technicians". The company's wholesale agents can supply them.

PARTS—*L. S. Brach Mfg. Corp.* of 55 Dickerson St., Newark, N. J., has just released for distribution its annual catalog No. 1038-R. Includes complete description of such products as home and multiple antenna systems and accessories, new auto aerials, an electric fence controller and other specialties. Free to *RR* readers on request.

CONDENSERS, RESISTORS—Listings of all standard items of the *Aerovox* line is provided in a new handy and condensed catalogue. Includes three pages of exact-duplicate replacement condenser listings and two pages of exact-duplicate motor-starting condenser listings. Copies available from the factory at 70 Washington St., Brooklyn, N. Y., or from jobbers.

ANTENNAS, BALLASTS ET. AL.—*J. F. D. Manufacturing* of 4111 Ft. Hamilton Parkway, Brooklyn, N. Y., announced catalog No. 3071RA. Contains description of vertical antenna with universal bracket, ac-dc ballast ballast unit tester, auto antennas, wire, field-coils, phono pickup coils and dampers, resistance type line cords, suppressors, test prods and clips.

VIBRATORS — From *Electronic Laboratories, Inc.*, 122 West New York St., Indianapolis, comes new catalogs completely describing company converters, polarity changers and vibrators. Complete details, pictures, prices, are given. A separate sheet covers recently introduced heavy duty converters and vibrators for industrial and other heavy manufacturing applications.

SOUND—*Atlas Sound* of 1447-51 39th St., Brooklyn, N. Y., has a new catalog No. W-38. Contains complete data on the firm's speakers, baffles, parabolic baffles, trumpets, mike stands, carrying cases and enclosures and the new line of WX type marine horns for cone speakers.

HOW TO BUILD—"How to Build Radio Receivers" (list 50c.) is the title of a 120 page book by *Meissner Manufacturing*. Contains many diagrams and construction articles on broadcast and shortwave and allwave sets, interesting dope about push-button tuners, phonoscillators, noise-silencers, other useful devices. Also has many pages devoted to design and construction hints, charts and tables of value to experimenters, amateurs, servicemen.

LOG, LEGS—*National Union* has just published a new edition of its "Radio Foto Log," listing at 15c. Contains a vast amount of American and foreign tuning data, program information and 151 photos of famous radio stars. New display panels by the same company, lithographed in six colors, mounted on easels, urge the consumer to keep sets in condition. Pretty girls, replete with lavishly displayed underpinning, are justifiably relied upon to stop traffic.

STAGE BY STAGE—Included in the second issue of the Weston "Pointer", published by the Weston Electrical Instrument Corporation of Newark, N. J., and available to servicemen, is an interesting discussion of stage-by-stage receiver analysis. Use of the vacuum tube voltmeter for this purpose is described.

CATALOGUE—A new catalog, number 29A, listing additional products for general radio and allied applications, has just been released by the Nash Radio Products Company of 5437 Lisette Ave., St. Louis. Free on request to servicemen if *Radio Retailing* is mentioned.

POCKET-SIZE SALESMAN—Appropriate as an aid for inside or outside salesmen handling the *Stromberg-Carlson* line, or for counter use, is a new booklet containing large illustrations of all existing models. The book is divided into sections: one for table types, one for conventional consoles, one for "styled" radios and another for radio-phonographs. In addition, pages are devoted to features such as the Labyrinth, Corner Consoles, Remote Control, Electric Flash Tuning, Ear Level Projection and the Carpinchoe leather speaker. Bound with spiral wire.

NOVELTY APPEAL—A glance at the new catalog "Wilcox-Gay for 1939" shows a set line full of novelty appeal. Models such as "The Thin Man" which lies, stands or hangs, and the pioneering wireless remote record player are backed up by a consistent grouping of table and console sets.

PETTY PICTURE — To *Crosley*, artist Petty, whose drawings in "Esquire" and elsewhere have what it takes, contributes a window display piece featuring the firm's new line of sets . . . plus feminine pulchritude in his own popular style. Available also in miniature sizes.

TUBE CHARTS—*Precision Apparatus* of 821 East New York Ave., Brooklyn, N. Y., offers to owners of its instrument models 500, 500A, 600 and 700 late tube charts (Form 7138).

CAMERA—*Universal Camera Corporation* of 28-30 West 23rd St., New York, offers a new four color window and counter display on the new *Univex Cine-8* movie camera. Copy stresses 60 new features.

AMPLIFIER GUIDE—Priced at 15 cents, the new *Thordarson* amplifier guide number 346-D is now ready. Contains many circuits for amplifiers of different power output ratings, together with actual chassis layout charts, parts lists and constructional details. Also contains much general data of interest to all men working with amplifiers.



LEININGER



ERICKSEN



LAWLER

Bendix Promotions, Additions

SOUTH BEND—Announcement made just as *Radio Retailing* closed, by Judson S. Sayre, vice-president in charge of sales of Bendix Home Appliances, indicated appointment of several new executives, advancement of others.

Wm. H. Leininger, former advertising and sales promotion manager, has been promoted to merchandising manager in the sales department. New head of the advertising and sales promotion department is Parker H. Ericksen, formerly advertising manager of Zenith Radio and Fairbanks-Morse. N. F. Lawler of Detroit has been appointed manager of the sales training department.

L. J. Chatten has been promoted from

district manager to regional manager in charge of the Eastern sales division. W. S. Reinhart has been promoted from the sales training department. C. H. Hunter has been made manager of the St. Louis territory, C. C. Ayres has been made manager of the Davenport area and W. A. Becker is now district manager at Pittsburgh.

Special Bendix sales reps just appointed are D. F. Gaches, H. H. Wilson and I. H. Faight.

New Vibrapowr Type

CHICAGO—The Pauley-James Corporation of this city announces that it is now in production on a complete line of synchronous vibrators. This new line in-

corporates all the mechanical and electrical features of the original non-synchronous Vibrapowr unit and, in addition, employs a new push-pull coil circuit. Replacement charts, listing all types, are available and may be secured by writing the company at 4619 Ravenswood Avenue.

Two New RCA Directors

CAMDEN—From George K. Throckmorton, president of the RCA Manufacturing Company, comes word that at the regular meeting of the Board of Directors Henry C. Bonfig and Gano Dunn were elected directors of the company. Mr. Bonfig is commercial vice-president. Mr. Dunn is president of the J. G. White Engineering Corporation.

YOUR LAST CHANCE!

★ DUES WILL BE INCREASED JANUARY 1, 1939

★ \$1.00 of 1938 dues will be credited on 1939 dues if you join before Jan. 1, 1939

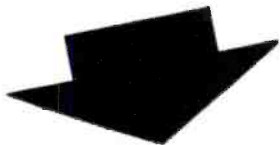

MAIL THIS COUPON!
RADIO SERVICEMEN OF AMERICA, INC.
 304 South Dearborn St., Chicago, Ill.

Gentlemen:
 I hereby make application for membership in the Radio Servicemen of America.

Name

Home Address

City

Firm Name

Address

I am enclosing \$2.00 National Yearly Dues. (Nominal Local Chapter Dues not included.)

State

RSA has pioneered and established these benefits for you. Join now—so you can get them:

- ★ Membership in the only Independent Servicemen's Organization in the industry.
- ★ Advanced Service Courses for Members. ★ Technical advice and assistance for members asking it. ★ Recognition by and representation in the entire servicing business.
- ★ RSA is as important to you as your job or your business. Don't wait—send your application in today!

THE BEST \$2.00 YOU EVER INVESTED. **RADIO SERVICEMEN OF AMERICA, INC.**
 JOE MARTY, Jr., Executive Sec'y. 304 S. Dearborn St., Chicago.

ADVERTISERS INDEX

	Page		Page
ABC Radio Labs.....	77	Million Radio & Television Labs.....	72
Aerovox Corp.....	76	National Union Radio Corp.....	60
American Microphone Co.....	69	Permo Products.....	31
Amperite Co.....	62, 78	Philco Radio & Television Corp.....	6, 80
Arcturus Radio Tube Co.....	77	Pioneer Gen-E-Motor Corp.....	48
Bell Sound Systems, Inc.....	75	Presto Recording Co.....	32
Bitter Const. Co., A.....	31	Quam-Nichols Co.....	62
Bogen Co., David.....	69	Radio City Products, Inc.....	58
Brach & Co., L. S.....	72	Radio Corporation of America.....	16
Cinaudagraph Corp.....	64	Rangertone, Inc.....	32
Clarostat Mfg. Co.....	75	Raytheon Production Corp.....	3
Consolidated Wire & Assoc. Corps.....	64	RCA Manufacturing Co., Commercial Sound.....	48
Cornell-Dubilier Elec. Corp.....	73	RCA Manufacturing Co., Set Division.....	24, 25, 26, 27
Cornish Wire Co.....	76	RCA Manufacturing Co., Tube Division.....	35, 36, 37, 38
Crosley Radio Corp.....	Inside Back Cover	Readrite Meter Works.....	74
Garrard Sales Corp.....	30	Recoton Corp.....	30
General Electric Co.....	Back Cover, 8	Regal Amplifier Corp.....	72
General Industries Corp.....	31	Remler Co., Ltd.....	41
Hickok Electrical Instrument Co.....	79	Rider, John F.....	62
Hygrade-Sylvania Corp.....	59	Scientific Diathermy.....	41
International Resistance Corp.....	68	Sentinel Radio Corp.....	41
Janette Manufacturing Co.....	41	Service Instruments, Inc.....	71
Jackson Elec. Instrument Co.....	77	Simpson Electric Co.....	63
Kato Engineering Co.....	31	Solar Manufacturing Co.....	77, 78
Ken-Rad Corp.....	69	Sprague Products Co.....	75
Mallory & Co., Inc., P. R.....	Inside Front Cover and 65	Standard Transformer Corp.....	69
Meissner Mfg. Co.....	5	Steem Electric Corp.....	48
		Stromberg Carlson Tele. Mfg. Co.....	2
		Supreme Instruments Co.....	66
		Triad Manufacturing Co.....	78
		Triplett Electrical Instrument Co.....	61
		Tung-Sol Radio Tubes, Inc.....	66
		Utah Radio Products Co.....	55
		Ward Products Co.....	78
		Webster-Chicago.....	70
		Weston Electrical Instrument Corp.....	53
		Wilcox-Gay Corp.....	29
		Wincharger Corp.....	4

SEARCHLIGHT SECTION (Classified Advertising)

	Page
Classification.....	
CATALOGS.....	87
EMPLOYMENT.....	86
RADIO STOCKS.....	
Burstin-Applebee Co.....	87
Clough-Brengle Co.....	87
Electro-Voice Mfg. Co., Inc.....	87
Knaphurst Co.....	87
Krank, Inc. A. J.....	87
Midwest Appliance Parts Co.....	87
Radolek Co.....	87
Terminal Radio Corp.....	87
Williams Philco, Inc.....	87

SEARCHLIGHT SECTION

EMPLOYMENT and BUSINESS OPPORTUNITIES—SURPLUS STOCKS—DISCONTINUED MODELS

UNDISPLAYED RATE:
15 cents a word, minimum charge \$3.00
Positions Wanted (full or part-time salaried employment only) ½ the above rates, payable in advance.
(See ¶ on Box Numbers.)
Proposals, 50 cents a line an insertion.

INFORMATION:
Box Numbers in care of our New York, Chicago and San Francisco offices count 10 words additional in undisplayed ads. Replies forwarded without extra charge.
Discount of 10% if one payment is made in advance for four consecutive insertions of undisplayed ads (not including proposals).

DISPLAYED—RATE PER INCH:
1 inch.....\$8.00
2 to 3 inches..... 7.80 per inch
4 to 7 inches..... 7.60 per inch
An advertising inch is measured vertically on one column, 3 columns—30 inches—to a page. Contract Rates on request.

(New advertisements must be received by December 1st for the December issue)

POSITION WANTED

RADIO STUDENT desires position in radio or electrical shop, store. Little experience. Frank McCosco, Springfield, Vt. c/o Oscar Bingham.

FOR SALE

For Sale
Cheap. Used less than year. Triplett 540 oscillator, 740 multimeter, 640 FP tester, and Philco 025 meter. Lincoln Radio Service, Star City, Arkansas.

LEGAL NOTICE

STATEMENT OF THE OWNERSHIP, MANAGEMENT, CIRCULATION, ETC., REQUIRED BY THE ACTS OF CONGRESS OF AUGUST 24, 1912, AND MARCH 3, 1933

Of Radio Retailing, published monthly at Albany, N. Y., for October 1, 1938.

State of New York } ss.
County of New York }

Before me, a Notary Public in and for the State and county aforesaid, personally appeared D. C. McGraw, who, having been duly sworn according to law, deposes and says that he is the Secretary of the McGraw-Hill Publishing Company, Inc., publishers of Radio Retailing, and that the following is, to the best of his knowledge and belief, a true statement of the owner-

LEGAL NOTICE

ship, management (and if a daily paper, the circulation), etc., of the aforesaid publication for the date August 24, 1912, as amended by the Act of March 3, shown in the above caption, required by the Act of 1933, embodied in section 537, Postal Laws and Regulations, printed on the reverse of this form, to wit:

1. That the names and addresses of the publisher, editor, managing editor, and business managers are: Publisher, McGraw-Hill Publishing Company, Inc., 330 West 42nd Street, N. Y. C. Editor, O. Fred Rost, 330 West 42nd Street, N. Y. C. Managing Editor, W. MacDonald, 330 West 42nd Street, N. Y. C. Business Manager, H. W. Mateer, 330 West 42nd Street, N. Y. C.

2. That the owner is: (If owned by a corporation, its name and address must be stated and also immediately thereunder the names and addresses of stockholders owning or holding one per cent or more of total amount of stock. If not owned by a corporation, the names and addresses of the individual owners must be given. If owned by a firm, company, or other unincorporated concern, its name and address, as well as those of each individual member, must be given.) McGraw-Hill Publishing Company, Inc., 330 West 42nd St., N. Y. C. Stockholders of which are: James H. McGraw, 330 West 42nd St., N. Y. C. James H. McGraw, Jr., 330 West 42nd St., N. Y. C. James H. McGraw, James H. McGraw, Jr., and Curtis W. McGraw, Trustees for: Harold W. McGraw, James H. McGraw, Jr., Donald C. McGraw, Curtis W. McGraw; Curtis W. McGraw, 330 West 42nd St., N. Y. C. Donald C. McGraw, 330 West 42nd St., N. Y. C. Anne Hugus Britton, 330 West 42nd St., N. Y. C. Mildred W. McGraw, Madison, N. J. Grace W. Mehren, 33 West Grand Ave., Chicago, Ill. J. Malcolm Muir and Guaranty Trust Co. of New York, Trustees for Lida Kelly Muir, 524 Fifth Avenue, N. Y. C. F. S. Wetherby, 271 Clinton Road, Brookline, Mass. Elsa M. Wilsey, Madison, N. J.

LEGAL NOTICE

3. That the known bondholders, mortgagees, and other security holders owning or holding 1 per cent or more of total amount of bonds, mortgages, or other securities are: (If there are none, so state.) None.

4. That the two paragraphs next above, giving the names of the owners, stockholders, and security holders, if any, contain not only the list of stockholders and security holders as they appear upon the books of the company but also, in cases where the stockholder or security holder appears upon the books of the company as trustee or in any other fiduciary relation, the name of the person or corporation for whom such trustee is acting, is given; also that the said two paragraphs contain statements embracing affiant's full knowledge and belief as to the circumstances and conditions under which stockholders and security holders who do not appear upon the books of the company as trustees, hold stock and securities in a capacity other than that of a bona fide owner; and this affiant has no reason to believe that any other person, association, or corporation has any interest direct or indirect in the said stock, bonds, or other securities than as so stated by him.

5. That the average number of copies of each issue of this publication sold or distributed, through the mails or otherwise, to paid subscribers during the twelve months preceding the date shown above is: (This information is required from daily publications only.)

D. C. McGRAW, Secretary.
McGraw-Hill Publishing Company, Inc.

Sworn to and subscribed before me this 26th day of September, 1938.

[SEAL] H. E. BEIRNE,
Notary Public, Nassau County, Clk's No. 84. N. Y. Clk's No. 98, Reg. No. 0-B-90.
(My commission expires March 30, 1940)

Special—While They Last!
**The CROSLEY
XERVAC**



DEMONSTRATORS
RECLAIMED

\$19.75

COMPLETE FOB ST. PAUL

Guaranteed in Perfect
Running Order

Dealers—here's your opportunity to get a famous Crosley Xervac at a mere fraction of the original cost! These are demonstrators and reclaimed machines, complete in every way, guaranteed to be in perfect running condition. We have only a limited number to sell at this amazingly low price. Take advantage of this outstanding bargain now—while they last.

Write or telegraph your order for one or more today!

A. J. KRANK, INC.
185 UNIVERSITY AVE., ST. PAUL, MINNESOTA

YOU ARE ONE

of more than 25,000 readers of RADIO RETAILING.

Your problems of selling radio sets, accessories and other home merchandise—whether business or individual—are duplicated with other readers, but—

Still OTHER readers can provide the solution of your problem IF THEY KNOW WHAT IT IS!

Tell them! Here!

Through classified advertising in the Searchlight Section of RADIO RETAILING—your business paper and theirs.

PROFIT or LOSS?

DON'T GUESS! Poor records do not provide adequate information for new tax and report forms now required.

Our expert, long experienced in Appliance and Radio business has provided for you a simple, complete bookkeeping system.

Appliance and Radio dealers everywhere can now have as good a system as the manufacturers who supply them.

Write for information today!

Have your bookkeeping expert check over this easy working plan.

Complete manual of instructions with each set of records.

Know where you stand. Write today!

THE KNAPHURST COMPANY
501 South Jefferson St., Chicago, Illinois

**OVER 10,000 PARTS
FOR VACUUM CLEANERS AND
WASHING MACHINES**

24-HOUR SERVICE!

Attach this "Ad" to Your Inquiry and Receive

"Special Inventory Reduction Price Sheet"

Manufacturers Factory Representatives

MIDWEST APPLIANCE PARTS CO.

2722 W. Division St. CHICAGO, ILL.

EVERYTHING IN RADIO!
Our immense stock of radio sets, parts and supplies enables you to purchase your entire needs on one order! You will find all your Most Recently Known Favorites in this big book which is FREE for the asking! Practically every order is shipped the same day it is received. Write for Catalog.

BURSTEIN-APPLEBEE CO.
1912-14 McGraw St., Kansas City, Mo.

MICROPHONE REPAIRS

CARBON—VELOCITY—DYNAMIC

ALL MAKES—ANY CONDITION

Write for Quotations

ELECTRO-VOICE MFG. CO., INC.

328 E. COLFAX AVE.

SOUTH BEND, INDIANA

PHILCO PARTS

For Dealers and Servicemen

FAST SHIPMENTS made anywhere.

Genuine Philco Parts and Tubes. Send 10¢ postage for Philco Replacement Parts Book. Catalog sent FREE.

WILLIAMS PHILCO INC.

800 S. Adams St. Peoria, Ill.

COMPLETE DYNAMIC TESTING

Direct, quick, practical instruction for complete 14-point check of all receivers with cathode ray, easily mastered by anyone who can read a circuit diagram. Without it, you're behind the times! Get your copy TODAY!

FREE WITH ANY C-B INSTRUMENT

Clough-Bregle Co., Chicago, Ill., U. S. A.

STOP! Here is the Most Complete Radio BUYING GUIDE!

The new 1939 Radolek Radio Profit Guide contains complete showings of Radio Repair Parts, Radio Receivers, Public Address Amplifiers, Speakers, Microphones, Service Test Instruments, Radio Technical Books, Special Radio Tools. Leading Standard Brands! Everything you will ever need in the Radio Business all at Lowest Prices. You save money at Radolek!

- Every item you get from Radolek is guaranteed. It must be right or we make it right. Standard merchandise produced by leading Manufacturers with Radolek's guarantee added!
- Everything in Radio promptly when you want it—and exactly what you want. Radolek's efficient organization backed by a huge stock of standard guaranteed quality merchandise insures you the fastest service in the Radio business. Twenty-five Thousand Servicemen customers depend on Radolek service and benefit by Radolek's LOWEST PRICES. Send Now for your copy of the Radolek Radio Profit Guide. It will help you make more money.

LOWEST PRICES
GUARANTEED QUALITY
FASTEST SERVICE

Send for your **FREE** Copy Now!

RADOLEK
601 W. Randolph St., Dept. A-25, CHICAGO

Name
Address
Serviceman? Dealer? Experimenter?

Audio Frequency...

Our Bit For Records

We would like to get the issues, numbers 2, 3 and 5 of the series of articles on the record business that were run in *Radio Retailing*, I believe December 1937, January 1938 and March 1938.

DES MOINES H. R. LINEBAUGH
Mgr., Sidles Company

Ok. We're sending them to you. Incidentally, the response to the six-article series to which you refer has been tremendous. This is as it should be for the author, Richard Gilbert, told everything a radio dealer needed to know about starting a record business and then making it pay. And the record business has been growing like a house afire this year. We may be flattering ourselves but we think these articles helped start the stampede.

At Least They Know How

Recently I was called in for the purpose of removing radio interference from a dental machine. After little success on my own I wrote to the manufacturer and received a prompt reply giving information needed to do the job.

My advice to any serviceman encountering noise from special equipment of this kind is to write direct to the manufacturer, who will know how to fix it.

HATFIELD, PENNA. JAMES L. ARMSTRONG

It's a pity manufacturers don't quiet their electrical equipment before they sell it. We've been urging this for years but have never been able to bring sufficient pressure to bear to drive home our point over the objections of production men who won't spend one cent extra unless driven to it. We still think quiet electrical equipment would advertise well and give manufacturers an "edge" over competitors in their public relations work.

Music We Like

I find *Radio Retailing* an excellent magazine and chock full of information. In fact, the technical section is far superior to "Electronics" magazine.

UNITED STATES FLEET A. J. BEAUDOIN
Destroyers, Battle Force,
U.S.S. Detroit

Pardon me, this is to acknowledge receipt of the copies of *Radio Retailing* for April and May and the "Tricks of the Trade" I just received.

Radio Retailing is a nice magazine and I ever realized worthwhile keeping within reach. As far as I've read, also, "Tricks of the Trade" is another wonderful service book that every serviceman must have.

CEBU CITY, P. I. J. MENDOZA

I am very much interested in your *Radio Retailing* "Tricks of the Trade" and I believe it is one of the most helpful books to the radio serviceman that was ever published. It has helped me find quickly some very tough problems in servicing sets that I could not get any dope on or even a circuit diagram.

WABASH, IND. LORNI M. ULSHAFFER

Since I have been getting *RR* I have found it one of the most interesting books I have ever read. I have often wondered how you could find all of the interesting articles which you have published. Please continue more about public address systems and recording. These are about the only subjects in radio in which I am at all interested. Any one who can help me out on these topics will know that I extremely appreciate all information passed on to me. Thanks for listening.

WATERVILLE, CONN. EVERETT LA CHANCE

Why Just One Copy?

I am very much pleased with my copy of "Tricks of the Trade." I read the monthly "Tricks," of course, and get a lot of good from them but by the time everyone in the place has read the magazine it is pretty sure to be misplaced just

when I need it so to have the hints all in one cover is a great convenience.

MISHAWAKA, IND. HARRY B. MILLER
Service Mgr., Floran S. Kelley Co.

Wiretapster Tapped

In your September issue, on page 31; can you give me the address of C. Arnold Austin?

NEW CAANAN, CONN. I. B. WOUNDY
The I. B. Woundy Co., Inc.

This is typical of a literal flood of letters following publication of our "Wiretapster" story. C. Arnold Austin may be reached at 23 West 60th Street, New York City.

Safety Valve

In this grim business of radio service your cartoon "Sales Static" is viewed by my friends and I as pleasant and to the point comedy relief. It never fails to satisfy that longing for expression, that pent-up something or other that comes from daily contacts with customers.

DETROIT EDMOND W. SIMONS

Glad you like our monthly cartoon. We strive to make it ring the bell with men who encounter similar situations every day, intend that it should provide relief for the pent-up feelings of dealers, salesmen and servicemen. The customer is always right but not in our "Sales Static" drawings!

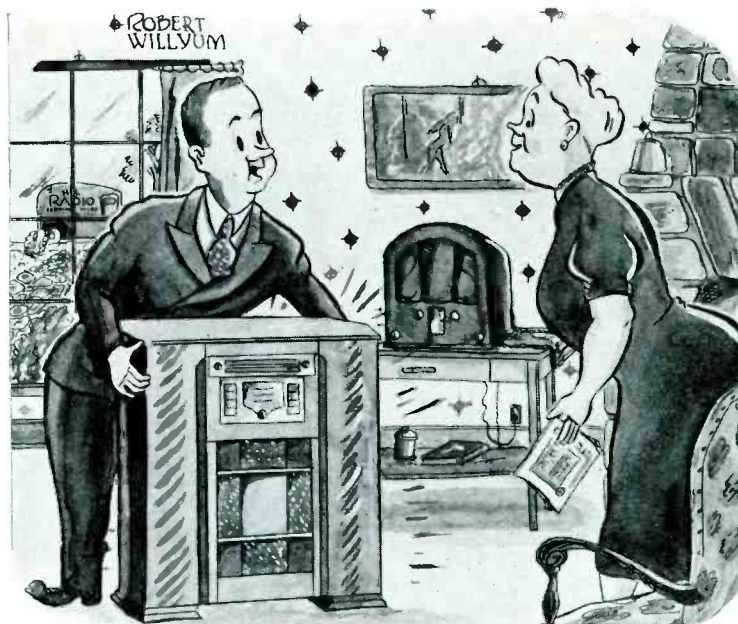

SALES STATIC... "I'll just set this new model here while I work on your old one. I didn't want to leave it out on the truck"

CROSLEY IS DEFINITELY the CHRISTMAS Volume Line!



The VANITY

PUSH BUTTON Radio at the market's lowest price. Knobs on end permit manual tuning also. Brown moulded case permits two playing positions. A volume seller when properly promoted. It has a wide Christmas appeal at its incredibly low price.

\$9.99*

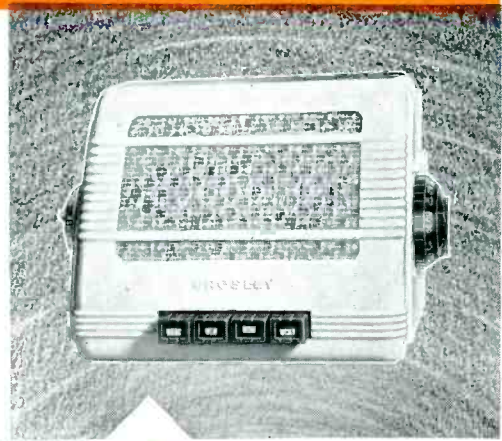

Super SEXTETTE

PUSH BUTTON, SUPERHETERODYNE, AC-DC, 6 TUBE (including ballast) with 5-inch dynamic speaker. A real achievement of Crosley engineers. Brown moulded cabinet of walnut finish. Introduces large vertical gold etched dial which is tuned by knob and push buttons are mounted on the top. Also in red and ivory at slightly higher price.

\$14.99*



Super VANITY

5-TUBE SUPERHETERODYNE! Astonishing radio reception and volume at an incredibly low price. Push buttons and knob tuning. It, too, has a wide Christmas appeal. It's compact — it's efficient! In ivory it's \$13.99.

\$12.99*



The SIXER

6 TUBE, 2 BAND, PUSH BUTTON, SUPERHETERODYNE, the sensational Crosley "Fiver" to which engineers have added another tube, developed more efficiency and housed in a beautifully moulded brown modern plastic cabinet. It is the season's sensation if sales are any indication. In red and ivory at slightly higher prices than brown, which is

\$19.99*



The TROUPER

5 TUBE (including ballast) AC-DC with beam power output and electro-dynamic speaker. Brown plastic case. Illuminated dial. Requires no ground. Easily carried when travelling. Only 8 inches long. Sensitive and sharp and surprising in resonant volume — truly a mighty mite of radio. In Ivory at \$9.99.

\$8.99*

*Prices F. O. B. Cincinnati (subject to change).

YOU'RE There WITH A

CROSLEY

THE CROSLEY RADIO CORPORATION, CINCINNATI
POWEL CROSLEY, Jr., President

TABLE MODELS, \$8.99 to \$39.95
CONSOLE MODELS, \$49.95 to \$99.50
COMBINATION MODELS (Phono-graph and Radio), \$24.95 to \$59.95

Home of WLW—"the Nation's Station"

*Nationally advertised to
33,500,000 Christmas Readers*

IN THE GREATEST CHRISTMAS PROMOTION
IN GENERAL ELECTRIC RADIO HISTORY



RADIOFORTÉ
MODEL G-95

RADIOGRANDE
MODEL G-76

TABLE MODEL
MODEL G-53

*For the Practical Person
with a Sentimental Side!*

**GET SET FOR TREMENDOUS G-E
RADIO CHRISTMAS BUSINESS**

This season General Electric Radio dealers will share in a bumper crop of Christmas sales.

G-E MEANS BUSINESS! Here's convincing proof. A gigantic concentrated barrage of G-E Christmas advertising in ten leading magazines will reach 33,500,000 readers. Every ad in full color—smashing 4-color spreads—sales-compelling 4-color pages. Can you afford—can any radio dealer afford not to line up—and stock up—with G-E Radio, NOW!

Get in touch with your G-E Radio distributor without delay.

GENERAL  ELECTRIC

**G-E LEADS WITH THESE
SALES-MAKING FEATURES:**

- **THE G-E BEAM-A-SCOPE**
No aerial—no ground wires. Reduces local static interference.
- **KEYBOARD TOUCH TUNING**
Easy. Accurate. Lightning Fast! Your program at the touch of a key.
- **G-E TIME TUNING**
Pick your programs on five different stations for 24 hours ahead—the G-E Automatic Program Pre-Selector does the rest. No re-tuning. No re-dialing.

 **RADIO**